

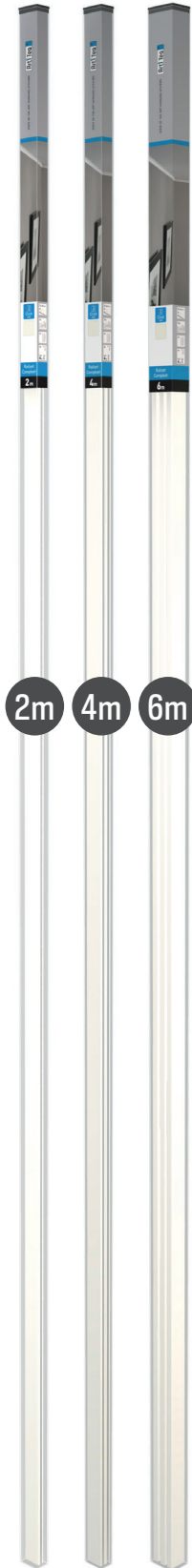







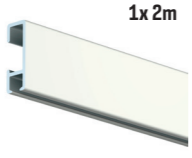

# CLICK RAIL





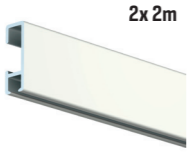

The Click Rail flexible picture hanging system is available in a variety of all-in-one kits: economy, a Twister with a 15-kg hook and a Twister with a 20-kg Micro Grip hook. These retail packages contain the rail, mounting materials and instruction sheet, hanging wires and hooks, and are available in 2-m, 4-m and/or 6-m sets. The all-in-ones kits offer a complete solution and are ready for immediate onward sale.

## ALL-IN-ONE CLICK RAIL ECONOMY

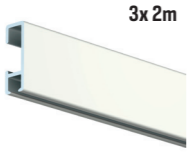



COMPLETE SET 2m				
	 1x 2m	 6x	 2x	 150 cm 2x max. 4 kg
CLICK RAIL WHITE RAL 9010	FASTENING MATERIAL	END CAP	SLIDER PERLON 2 mm HOOK 4 kg	
ARTICLE NO. 9.5621				



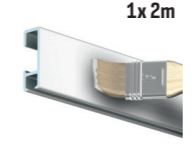

COMPLETE SET 4m				
	 2x 2m	 12x	 2x	 150 cm 3x max. 4 kg
CLICK RAIL WHITE RAL 9010	FASTENER MATERIAL	END CAP	SLIDER PERLON 2 mm HOOK 4 kg	
ARTICLE NO. 9.5627				



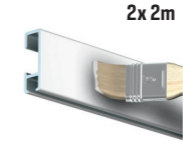

COMPLETE SET 6m				
	 3x 2m	 18x	 2x	 150 cm 4x max. 4 kg
CLICK RAIL WHITE RAL 9010	FASTENER MATERIAL	END CAP	SLIDER PERLON 2 mm HOOK 4 kg	
ARTICLE NO. 9.5629				



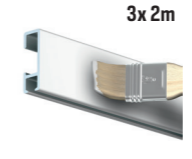

# CLICK RAIL

## ALL-IN-ONE CLICK RAIL ECONOMY

COMPLETE SET 2m				
	 1x 2m	 6x	 2x	 150 cm 2x max. 4 kg
CLICK RAIL WHITE PRIMER RAL 9016	FASTENER MATERIAL	END CAP	SLIDER PERLON 2 mm HOOK 4 kg	
ARTICLE NO. 9.5623				

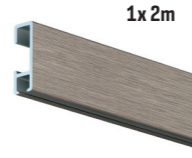
COMPLETE SET 4m				
	 2x 2m	 12x	 2x	 150 cm 3x max. 4 kg
CLICK RAIL WHITE PRIMER RAL 9016	FASTENER MATERIAL	END CAP	SLIDER PERLON 2 mm HOOK 4 kg	
ARTICLE NO. 9.5628				

COMPLETE SET 6m				
	 3x 2m	 18x	 2x	 150 cm 4x max. 4 kg
CLICK RAIL WHITE PRIMER RAL 9016	FASTENER MATERIAL	END CAP	SLIDER PERLON 2 mm HOOK 4 kg	
ARTICLE NO. 9.5630				

COMPLETE SET 2m				
	 1x 2m	 6x	 2x	 150 cm 2x max. 4 kg
CLICK RAIL ALU BRUSHED	FASTENER MATERIAL	END CAP	SLIDER PERLON 2 mm HOOK 4 kg	
ARTICLE NO. 9.5622				