



SIGN HANGING SYSTEMS

SIGN HANGING SYSTEMS

As a product specialist in the field of hanging concepts, Artiteq has been developing flexible hanging systems for paintings, presentation materials and signage within a building from Tilburg (NL) since 1995.

In addition to our core range of picture hanging systems, Artiteq offers a diverse range within Signing. For safe and correct hanging of panels, signing and signage within a building. In schools, hospitals and (larger) office buildings, for example, it is important that classrooms, escape routes, toilets and floors are properly indicated. As a hanging specialist, Artiteq offers several signing products to hang the signage in a simple and appropriate way.

In this brochure we explain the products and show the product range. The choice for which system depends on the situation, where it will be hung and what kind of ceiling or wall it is.

PROFESSIONAL
SAFE
FLEXIBLE





CEILING
▶ 4

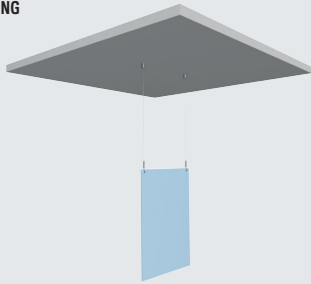

CEILING SLANTED WALLS
▶ 5

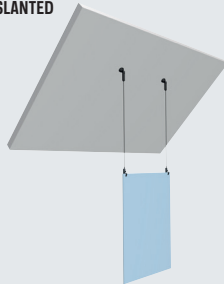

CEILING ACOUSTIC
▶ 6

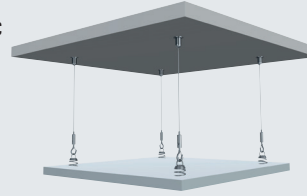

RECESSED CEILING
▶ 7

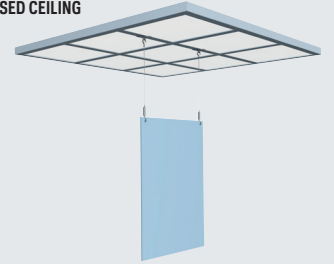

XPO RAIL
▶ 8

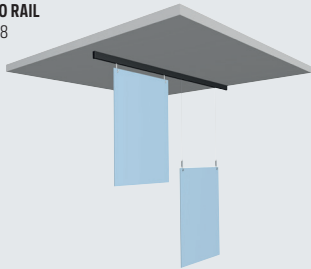

XPO RAIL LOW HANGING
▶ 9

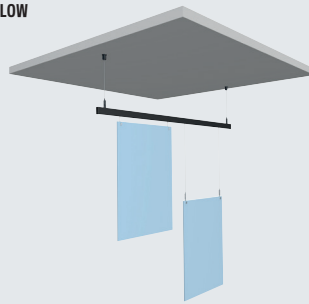

LOOP HANGER
▶ 10

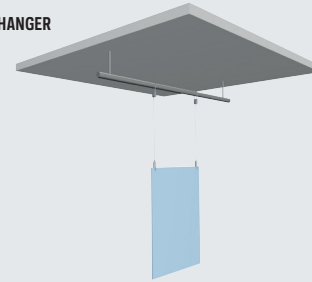

RECESSED CEILING CLIP
▶ 11

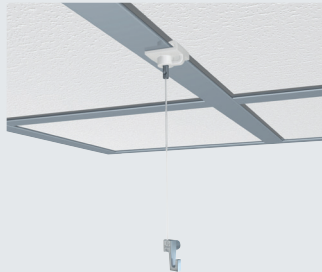

DROP CEILING CLIPPHANGER
▶ 12









DROP CEILINGHANGER
▶ 13







▶ CEILING







A

A1			A2			A3
						
CEILING BRACKET BLACK CO1BL	FISCHER DUOPOWER 5 X 25 5 MM	SCREW 3,5 X 40 MM	CEILING BRACKET NICKEL CO1NI	FISCHER DUOPOWER 5 X 25 5 MM	SCREW 3,5 X 40 MM	CEILING SUSPENSION AUTO GRIP 1,2 MM CSD1NI
7807.100	9.4934	9.4945	7807.110	9.4934	9.4945	7807.140

B

B1	B2	B3	B4
			
STEELWIRE + SLIDER 1,2 MM 300 CM BLACK	STEELWIRE + SLIDER 1,2 MM 300 CM NICKEL	STEELWIRE 7 x 7 1,2 MM 10 M*	STEELWIRE BLACK 7 X 7 1,2 MM 3 M*
7807.200	7807.210	7807.350	7807.360

C

C1	C2	C3	C4	C5	C6	C7
						
STEELWIRE HOOK AUTO GRIP 1,2 MM ST01BL	STEELWIRE HOOK AUTO GRIP 1,2 MM ST01NI	STEELWIRE HOOK AUTO GRIP 1,2 MM ST02NI	STEELWIRE HOOK AUTO GRIP 1,2 MM ST03NI	STEELWIRE CLAMPHOOK AUTO GRIP 1,2 MM STC01NI	STEELWIRE HOOK AUTO GRIP 1,2 MM STD01NI NICKEL	STEELWIRE HOOK AUTO GRIP 1,2 MM STD01BL BLACK
7807.010	7807.020	7807.030	7807.040	7807.050	7807.080	7807.070

D

COMPLETE SET

SET CEILING 2X STEELWIRE 1,2 MM 300 CM + 2X CEILING BRACKET NICKEL + 2X STEELWIRE HOOK
7807.520

* CABLE CUTTER 7807.900 AVAILABLE FOR USE WITH STEELWIRE 7 X 7 1,2 MM

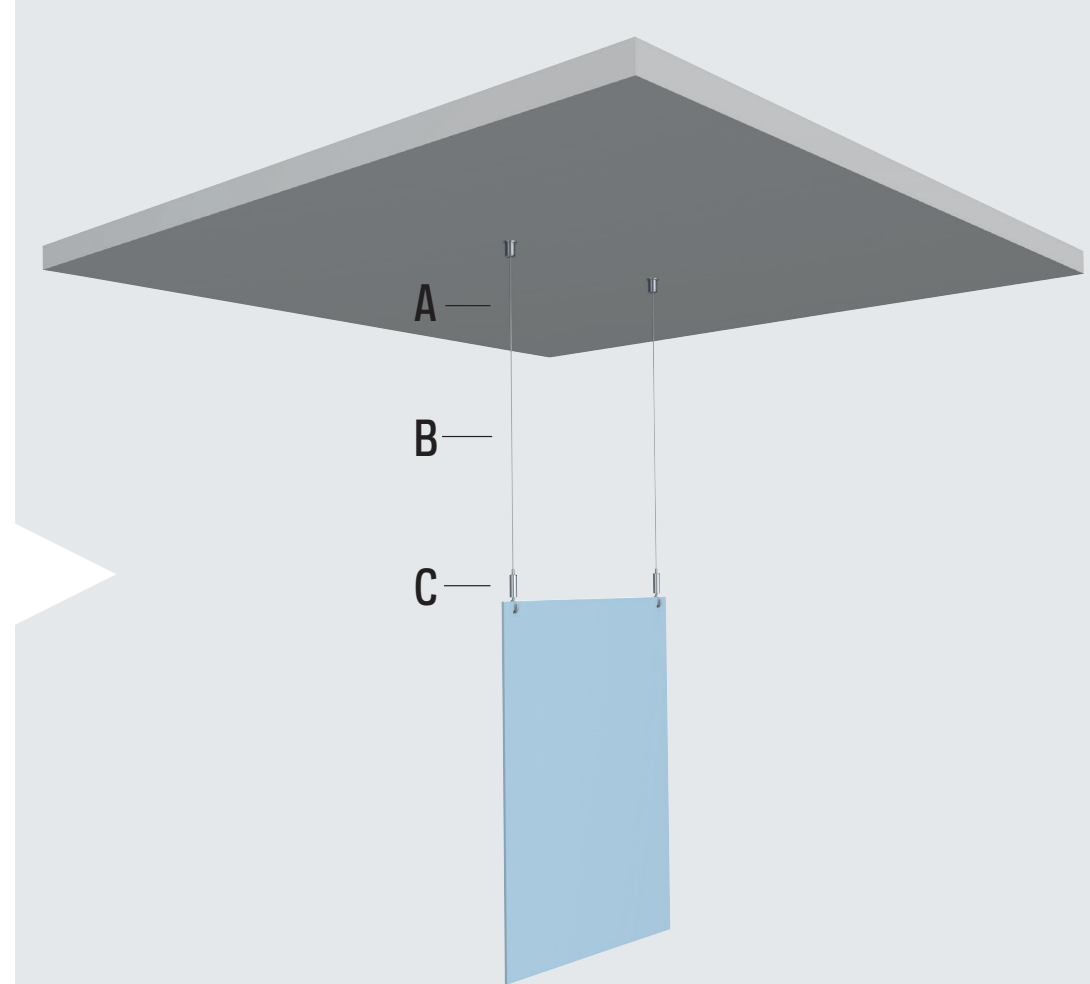

COMBINATION SHOWN: A2 + B2 + C3



POSSIBLE COMBINATIONS: A1/A2 + B1/B2 + C1/C2/C3/C4/C5/C6/C7
A3 + B3/B4 + C1/C2/C3/C4/C5/C6/C7

► CEILING SLANTED WALLS







A

A1	A2
	
CEILING BRACKET AUTO GRIP SILVER	CEILING BRACKET AUTO GRIP BLACK
7807.160	7807.150

B

B1	B2
	
STEELWIRE 7 X 7 1,2 MM 10 M*	STEELWIRE BLACK 7 X 7 1,2 MM 3 M*
7807.350	7807.360

C

C1	C2	C3	C4	C5	C6	C7
						
STEELWIRE HOOK AUTO GRIP 1,2 MM ST01BL	STEELWIRE HOOK AUTO GRIP 1,2 MM ST01NI	STEELWIRE HOOK AUTO GRIP 1,2 MM ST02NI	STEELWIRE HOOK AUTO GRIP 1,2 MM ST03NI	STEELWIRE CLAMPHOOK AUTO GRIP 1,2 MM STC01NI	STEELWIRE HOOK AUTO GRIP 1,2 MM STD01NI NICKEL	STEELWIRE HOOK AUTO GRIP 1,2 MM STD01BL BLACK
7807.010	7807.020	7807.030	7807.040	7807.050	7807.080	7807.070

* CABLE CUTTER 7807.900 AVAILABLE FOR USE WITH STEELWIRE 7 X 7 1,2 MM

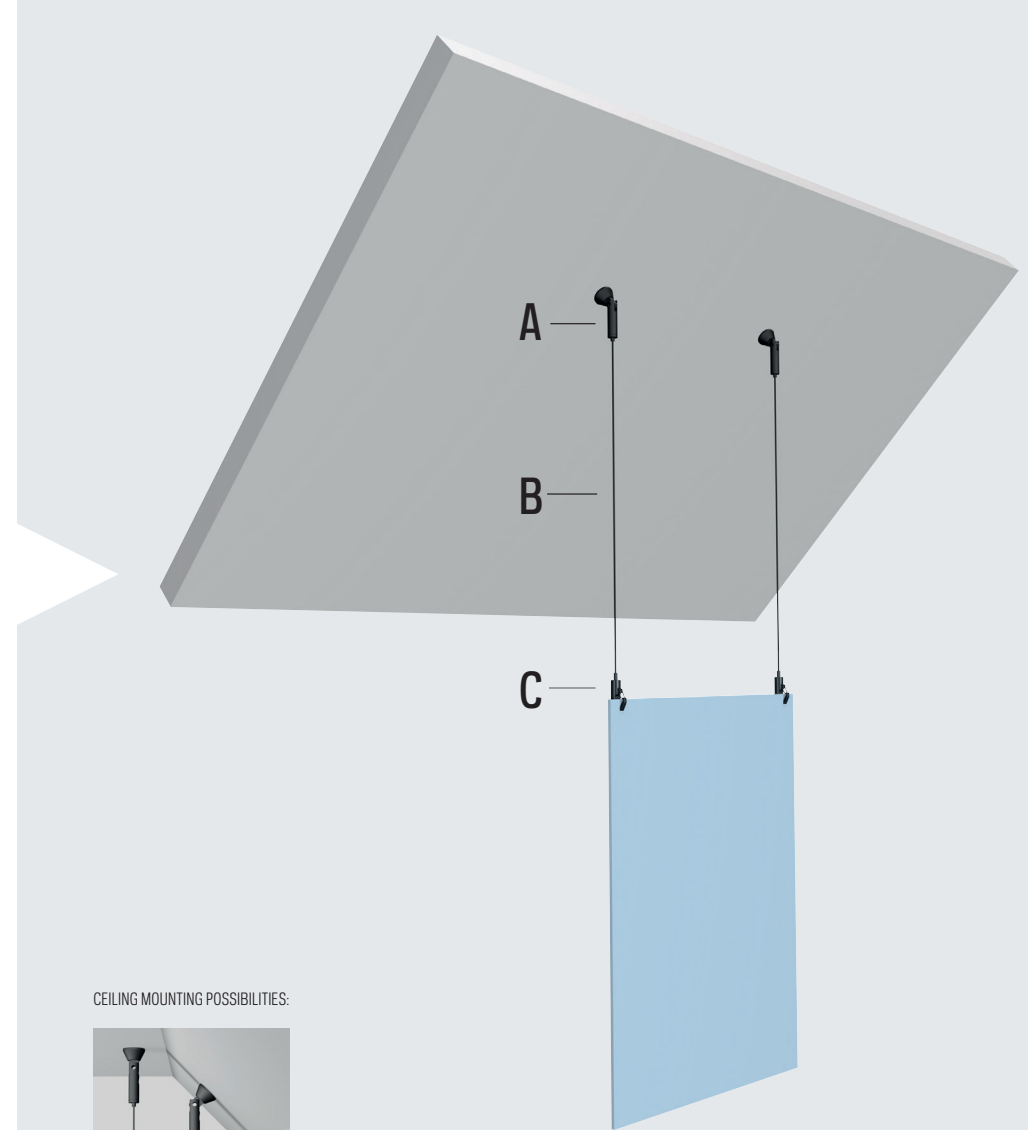







CEILING MOUNTING POSSIBILITIES:











COMBINATION SHOWN: A2 + B2 + C1

POSSIBLE COMBINATIONS: A1/A2 + B1/B2 + C1/C2/C3/C4/C5/C6/C7

▶ CEILING ACOUSTIC

A1			A2			A3
						
CEILING BRACKET BLACK C01BL	FISCHER DUOPOWER 5 X 25 5 MM	SCREW 3,5 X 40 MM	CEILING BRACKET NICKEL C01NI	FISCHER DUOPOWER 5 X 25 5 MM	SCREW 3,5 X 40 MM	CEILING SUSPENSION AUTO GRIP 1,2 MM CS01NI
7807.100	9.4934	9.4945	7807.110	9.4934	9.4945	7807.140

B1	B2	B3	B4
			
STEELWIRE + SLIDER 1,2 MM 300 CM BLACK	STEELWIRE + SLIDER 1,2 MM 300 CM NICKEL	STEELWIRE 7 x 7 1,2 MM 10 M*	STEELWIRE BLACK 7 X 7 1,2 MM 3 M*
7807.200	7807.210	7807.350	7807.360

C1	C2	C3	C4
			
STEELWIRE HOOK AUTO GRIP 1,2 MM ST01BL	STEELWIRE HOOK AUTO GRIP 1,2 MM ST01NI	STEELWIRE HOOK AUTO GRIP 1,2 MM ST02NI	STEELWIRE HOOK AUTO GRIP 1,2 MM ST03NI
7807.010	7807.020	7807.030	7807.040

D

ACOUSTIC SPRING 01-NI
7807.400



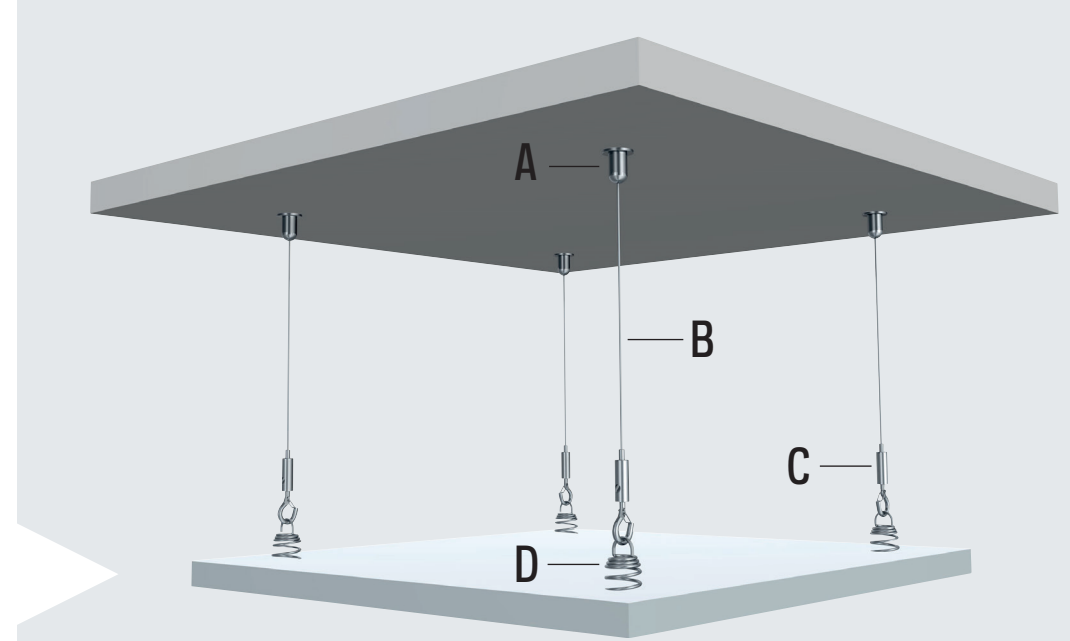











* CABLE CUTTER 7807.900 AVAILABLE FOR USE WITH STEELWIRE 7 x 7 1,2 MM



COMBINATION SHOWN: A2 + B2 + C4 + D

POSSIBLE COMBINATIONS: A1/A2 + B1/B2 + C1/C2/C3/C4 + D
A3 + B3/B4 + C1/C2/C3/C4 + D

► RECESSED CEILING

A	A1		A2		A3		
							
	RECESSED CEILING CLIP 24 MM 7807.120		RECESSED CEILING CLIP 24 MM + SUSPENSION AUTO GRIP 1,2 MM 7807.130		RECESSED CEILING CLIP BLACK 24 MM 7807.121		
B	B1		B2		B3		
							
	STEELWIRE + HOOK 1,2 MM 300 CM 7807.310		STEELWIRE 7 x 7 1,2 MM 10 M* 7807.350		STEELWIRE BLACK 7 X 7 1,2 MM 3 M* 7807.360		
C	C1	C2	C3	C4	C5	C6	C7
							
	STEELWIRE HOOK AUTO GRIP 1,2 MM STD1BL 7807.010	STEELWIRE HOOK AUTO GRIP 1,2 MM STD1NI 7807.020	STEELWIRE HOOK AUTO GRIP 1,2 MM STD2NI 7807.030	STEELWIRE HOOK AUTO GRIP 1,2 MM STO3NI 7807.040	STEELWIRE CLAMPHOOK AUTO GRIP 1,2 MM STC01NI 7807.050	STEELWIRE HOOK AUTO GRIP 1,2 MM STD01NI NICKEL 7807.080	STEELWIRE HOOK AUTO GRIP 1,2 MM STD01BL BLACK 7807.070
D	COMPLETE SET						
							
	SET RECESSED CEILING 2X STEELWIRE 1,2 MM 300 CM + 2X RECESSED CEILING CLIP + 2X STEELWIRE HOOK 7807.510						

* CABLE CUTTER 7807.900 AVAILABLE FOR USE WITH STEELWIRE 7 X 7 1,2 MM

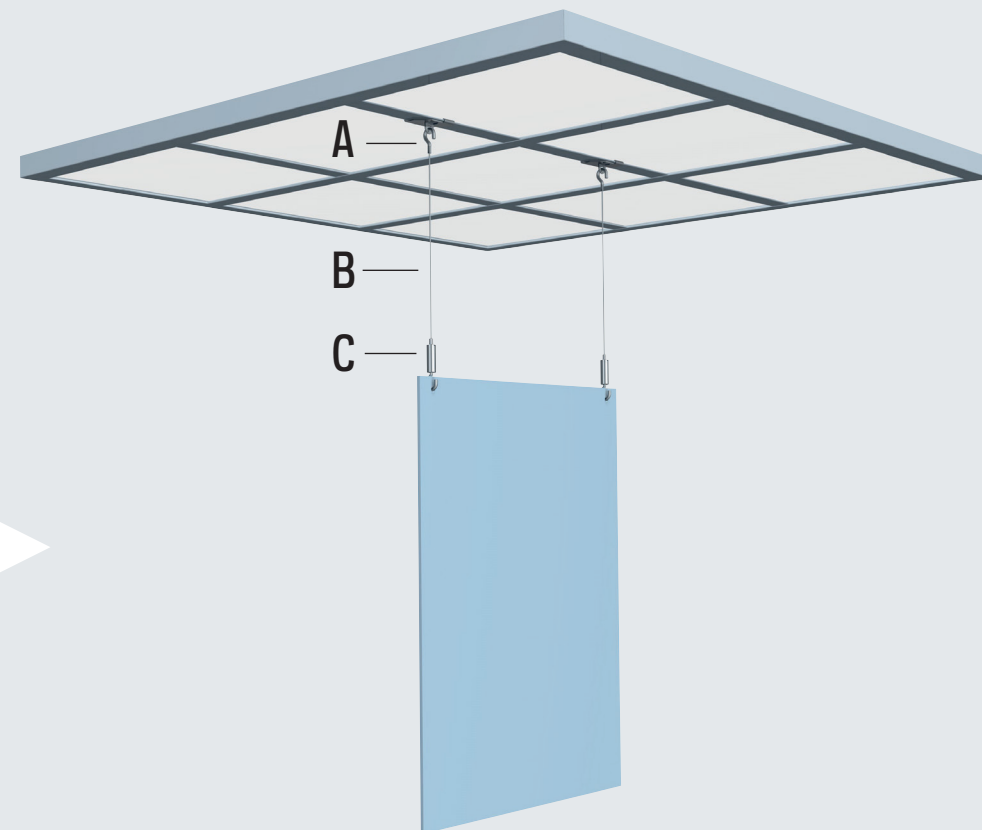

COMBINATION SHOWN: A1 + B1 + C3

POSSIBLE COMBINATIONS: A1 + B1 + C1/C2/C3/C4/C5/C6/C7
A2 + B2/B3 + C1/C2/C3/C4/C5/C6/C7

▶ XPO RAIL

A

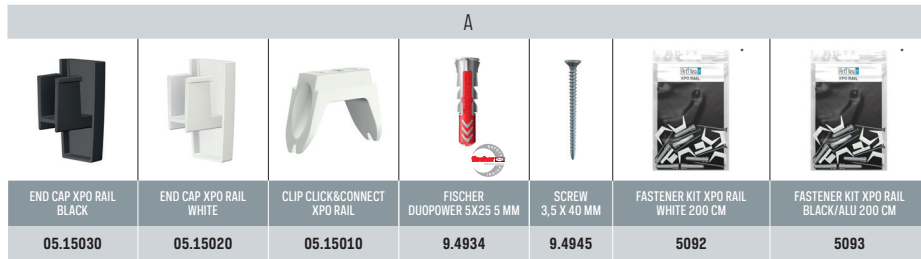
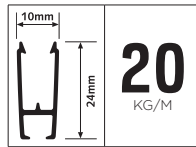
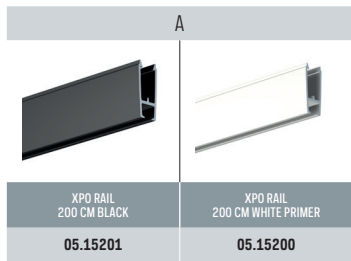

B

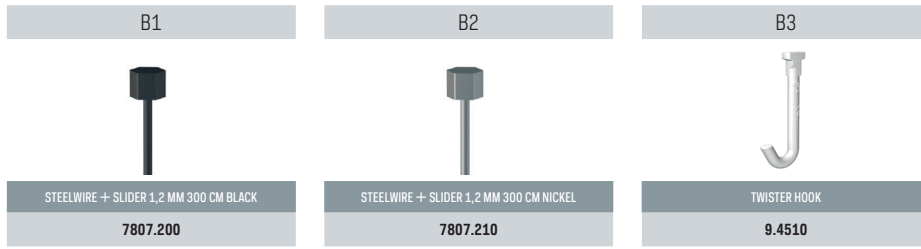

C

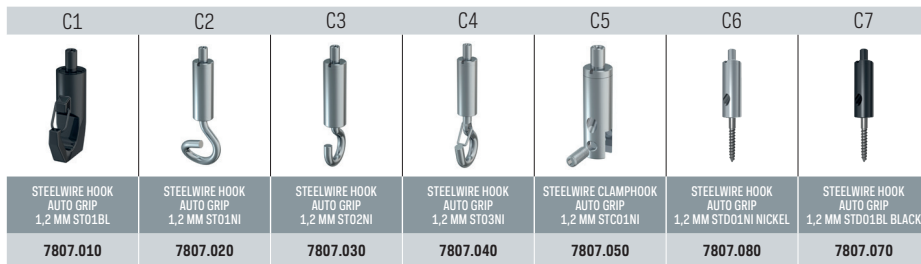

* CONTENT FASTENER KIT



		NUMBER 200 CM
05.15010	CLIP XPO RAIL	6x
9.4934	PLUG FISCHER 5 MM	6x
9.4945	SREW TBV PLUG FISCHER 5 MM	6x
05.15020 / 05.15030	END CAP XPO RAIL WHITE / BLACK	2x
2639	INSTRUCTION	1x



installation video

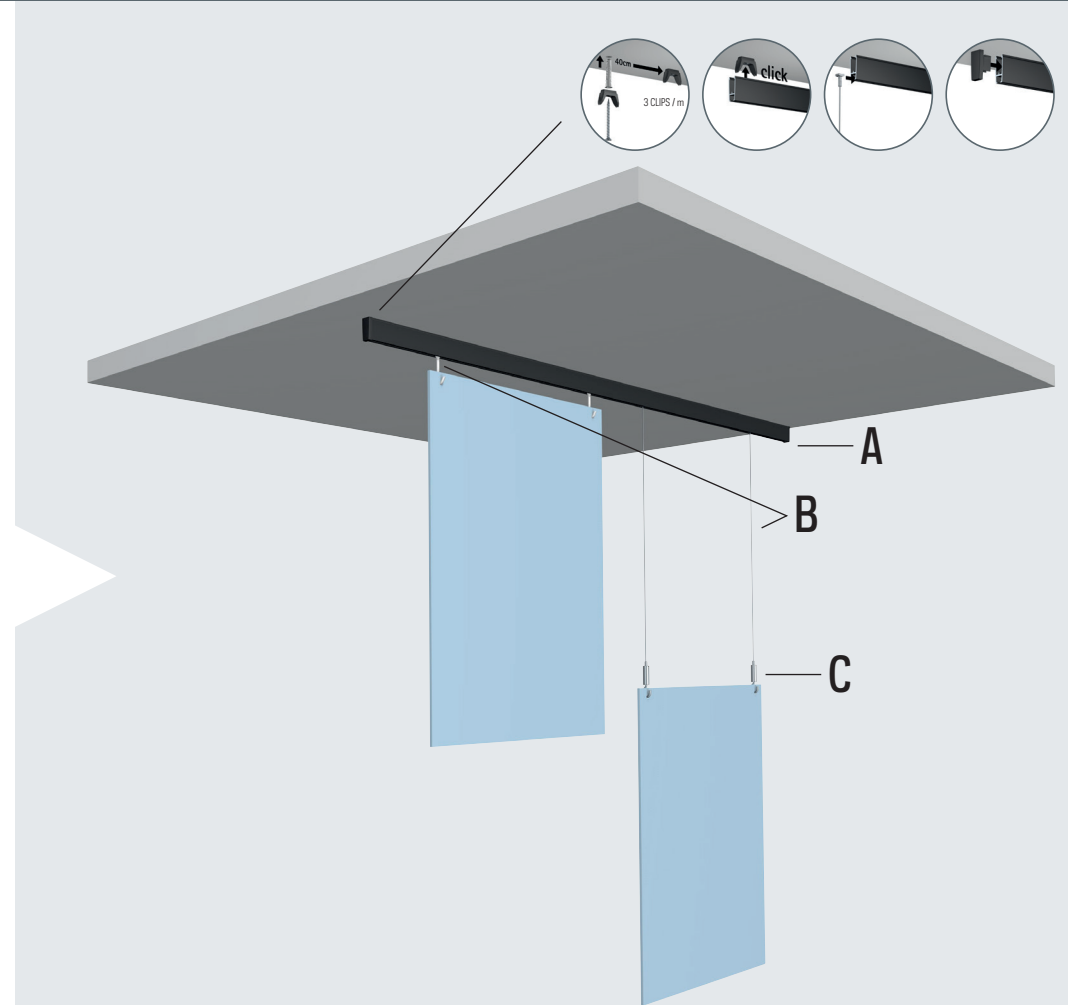







COMBINATION SHOWN:





A + B3
A + B2 + C3



POSSIBLE COMBINATIONS:



A + B1/B2 + C1/C2/C3/C4/C5/C6/C7
A + B3







▶ XPO RAIL LOW HANGING

A1			A2			A3
						
CEILING BRACKET BLACK Co1BL	FISCHER DUOPOWER 5 X 25 5 MM	SCREW 3,5 X 40 MM	CEILING BRACKET NICKEL Co1NI	FISCHER DUOPOWER 5 X 25 5 MM	SCREW 3,5 X 40 MM	CEILING SUSPENSION AUTO GRIP 1,2 MM CS01NI
7807.100	9.4934	9.4945	7807.110	9.4934	9.4945	7807.140

B1	B2	B3	B4
			
STEELWIRE + SLIDER 1,2 MM 300 CM BLACK	STEELWIRE + SLIDER 1,2 MM 300 CM NICKEL	STEELWIRE 7 x 7 1,2 MM 10 M*	STEELWIRE BLACK 7 X 7 1,2 MM 3 M*
7807.200	7807.210	7807.350	7807.360

C		
		
SUSPENSION BRACKET XPO RAIL 1,2 MM	XPO RAIL 200 CM BLACK	END CAP XPO RAIL BLACK
7807.060	05.15201	05.15030

D1	D2	D3
		
STEELWIRE + SLIDER 1,2 MM 300 CM BLACK	STEELWIRE + SLIDER 1,2 MM 300 CM NICKEL	TWISTER HOOK
7807.200	7807.210	9.4510

E1	E2	E3	E4	E5	E6	E7
						
STEELWIRE HOOK AUTO GRIP 1,2 MM STD1BL	STEELWIRE HOOK AUTO GRIP 1,2 MM STD1NI	STEELWIRE HOOK AUTO GRIP 1,2 MM STO2NI	STEELWIRE HOOK AUTO GRIP 1,2 MM STO3NI	STEELWIRE CLAMPHOOK AUTO GRIP 1,2 MM STCO1NI	STEELWIRE HOOK AUTO GRIP 1,2 MM STD01NI NICKEL	STEELWIRE HOOK AUTO GRIP 1,2 MM STD01BL BLACK
7807.010	7807.020	7807.030	7807.040	7807.050	7807.080	7807.070

* CABLE CUTTER 7807.900 AVAILABLE FOR USE WITH STEELWIRE 7 X 7 1,2 MM

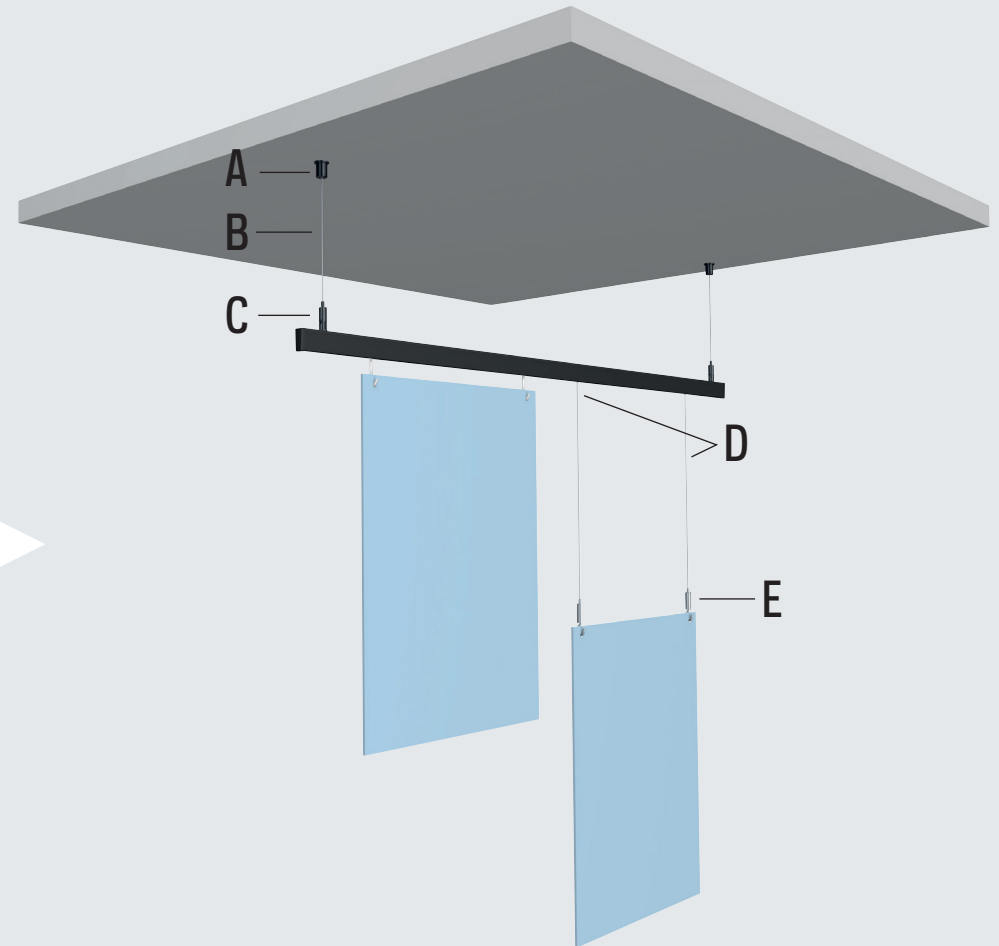

COMBINATION SHOWN: A1+B2+C+D2+E3 / A1+BD+C+D3

POSSIBLE COMBINATIONS:
 A1/A2 + B1/B2 + C + D1/D2 + E1/E2/E3/E4/E5/E6/E7
 A1/A2 + B1/B2 + C + D3
 A3 + B3/B4 + C + D1/D2 + E1/E2/E3/E4/E5/E6/E7
 A3 + B3/B4 + C + D3

▶ LOOP HANGER

A



B

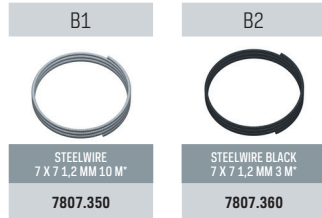

C

C1	C2	C3	C4	C5	C6	C7
STEELWIRE HOOK AUTO GRIP 1,2 MM STD1BL	STEELWIRE HOOK AUTO GRIP 1,2 MM STD1NI	STEELWIRE HOOK AUTO GRIP 1,2 MM STD2NI	STEELWIRE HOOK AUTO GRIP 1,2 MM STD3NI	STEELWIRE CLAMP- HOOK AUTO GRIP 1,2 MM STC01NI	STEELWIRE HOOK AUTO GRIP 1,2 MM STD01NI NICKEL	STEELWIRE HOOK AUTO GRIP 1,2 MM STD01BL BLACK
7807.010	7807.020	7807.030	7807.040	7807.050	7807.080	7807.070

D

COMPLETE SET 1	COMPLETE SET 2
SET LOOP HANGER STEELWIRE 1,2 MM 300 CM + HOOK	SET LOOP HANGER STEELWIRE 1,2 MM 300CM + LOOP
7840.300	7840.310

* CABLE CUTTER 7807.900 AVAILABLE FOR USE WITH STEELWIRE 7 x 7 1,2 MM

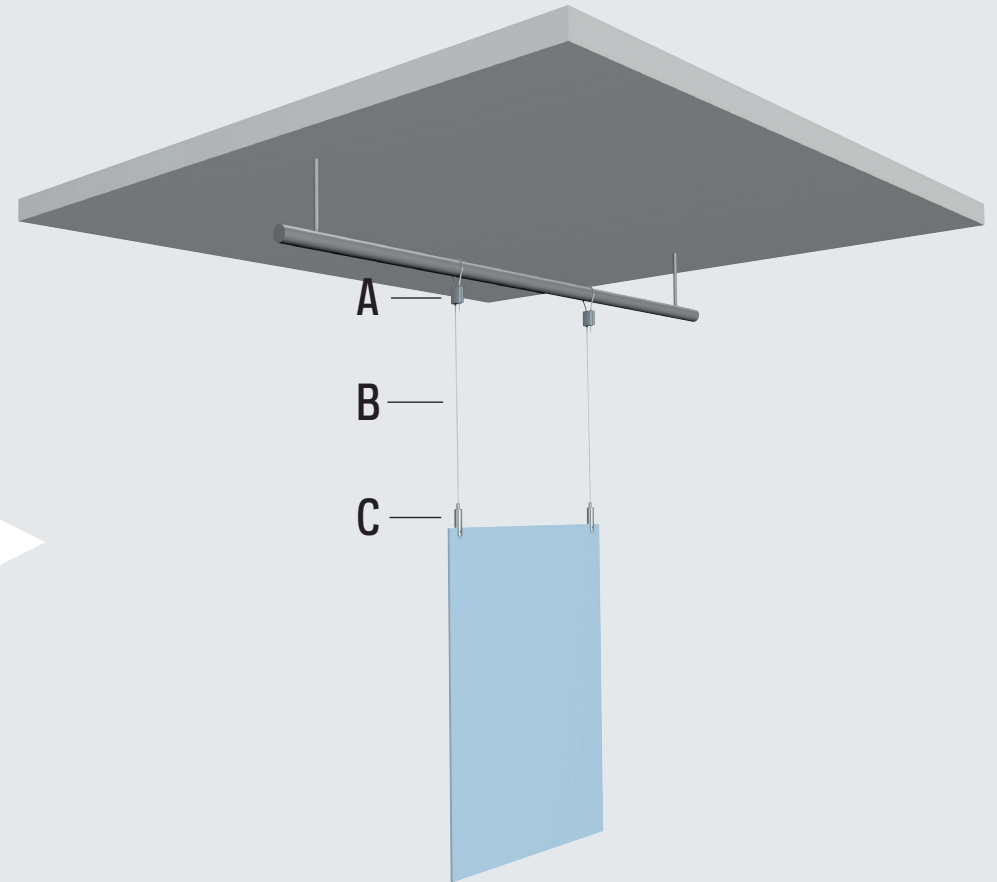

COMBINATION SHOWN: A + B1 + C5

POSSIBLE COMBINATIONS: A + B1/B2 + C1/C2/C3/C4/C5/C6/C7

► RECESSED CEILING CLIP

A



B

B1	B2	B3	B4
TWISTER 1 MM PERLTON	TWISTER 2 MM PERLTON	SLIDER ECONOMY 2 MM PERLTON	PERLTONWIRE 2 MM SPOOL
30.21150 150 CM	09.23100 100 CM	9.4424 100 CM	9.4404 100 CM
30.21200 200 CM	09.23150 150 CM	9.4425 150 CM	9.4421S 500 CM
30.21300 300 CM	09.23200 200 CM	9.4426 200 CM	WIRE CLAMP 2 MM ALU
	09.23250 250 CM	9.4427 250 CM	9.4431
	09.23300 300 CM	9.4428 300 CM	
	09.23500 500 CM		

C

C1	C2
AUTO GRIP	MINI HOOK
30.41100	9.4205

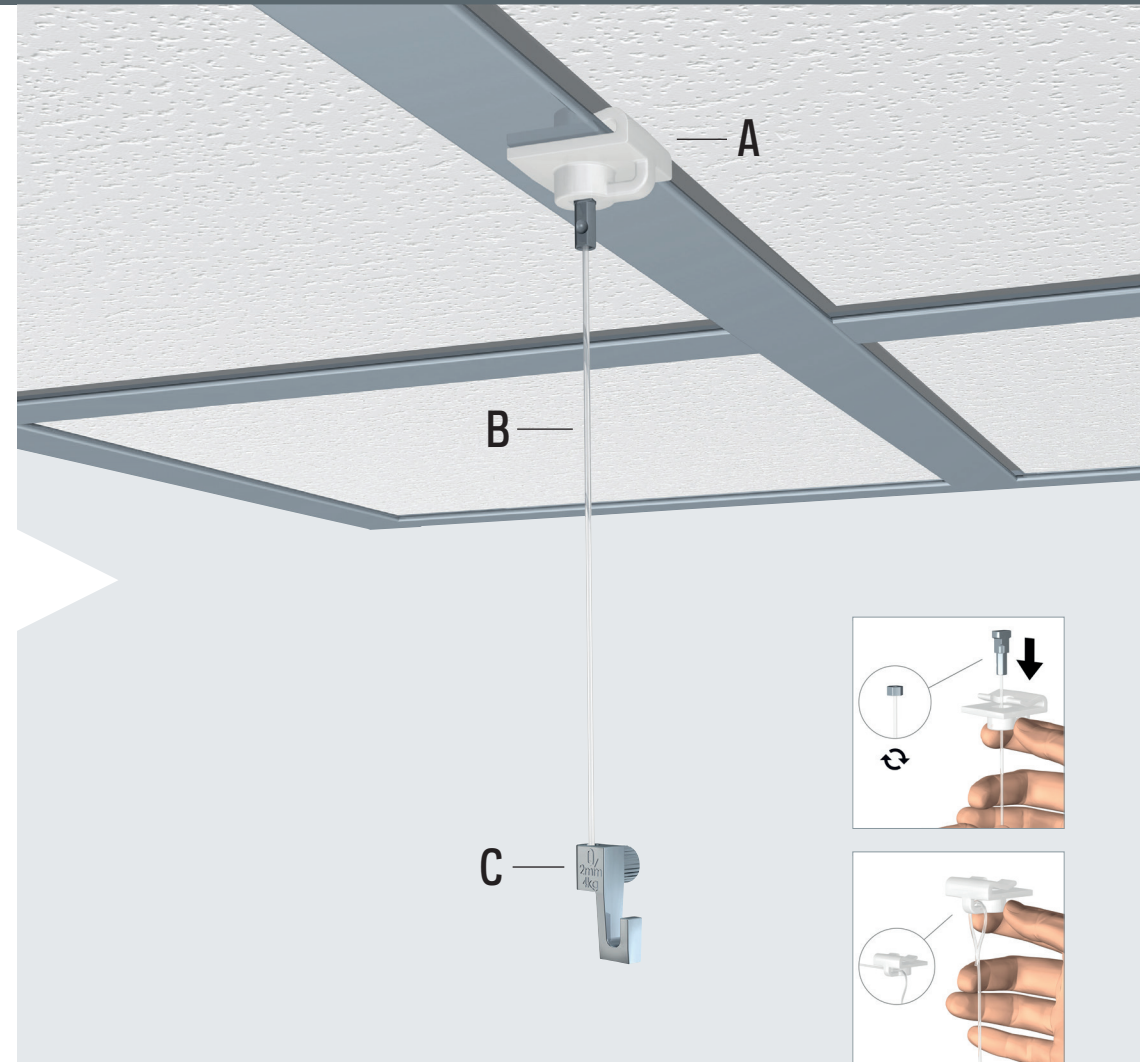

COMBINATION SHOWN: A1 + B2 + C2

POSSIBLE COMBINATIONS:
 A1 + B3 + C2
 A1 + B2 + C2
 A1 + B1 + C1
 A1 + B4 + C2

▶ DROP CEILING CLIP HANGER

COMPLETE SET

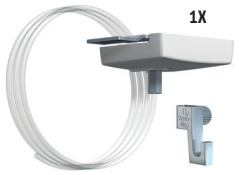

SET DROP CEILING CLIP HANGER WHITE
1X 200 CM PERLON WIRE + MINI HOOK 4 KG

7807.560

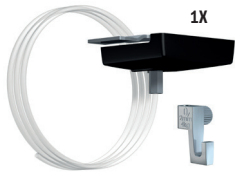

SET DROP CEILING CLIP HANGER BLACK
1X 200 CM PERLON WIRE + MINI HOOK 4 KG

7807.561

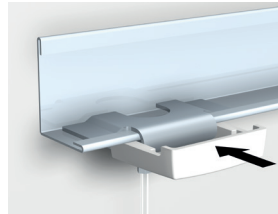
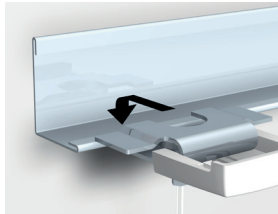

MAX

4

KG/M

10

YEARS
WARRANTY



► DROP CEILINGHANGER

DROP CEILINGHANGER



DROP CEILINGHANGER

7807.135

HANGING WIRE



9.4424

SLIDER ECONOMY

9.4425

SLIDER ECONOMY

9.4426

SLIDER ECONOMY

9.4427

SLIDER ECONOMY

9.4428

SLIDER ECONOMY

HOOK



9.4205

4 KG MANUAL



MAX

4

KG/M

10

YEARS
WARRANTY

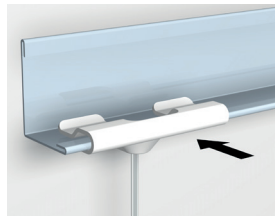
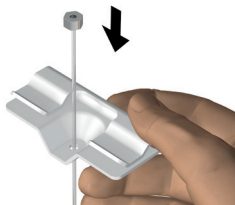

► SIGN HANGING SYSTEMS

Artiteq has selected the Fischer UX 5x30 R plug to be used in combination with its hanging systems. The Fischer UX 5x30 R plug can be used in different kinds of materials, such as concrete, stone and plasterboard. Depending on the material, the plug can support a maximum load of **30 kg**. The drill used with the plug must have a diameter of 5 mm. The plug is 30 mm in length. The screw used with the plug is 38 mm long and has a diameter of 3.5 mm (to be used in combination with a PZ2 bit).

To determine the maximum load of a signing hanging system, it must be known what type of mounting materials will be used and what surface (i.e. type of material) these will be attached to. The components of the signing hanging system all have a maximum bearing capacity. This is the maximum bearing capacity for the component itself and not the maximum bearing capacity that must be taken into account for the system as a whole. For the whole system, the load capacity that is recommended for the mounting material in combination with the respective base material, takes precedence.

For every signing hanging system, the weight that you wish to hang must be balanced against the maximum load capacity of the mounting material. If systems are hung from other hanging components, such as recessed ceilings, you have to know the maximum load of this hanging component before fitting our systems. The tables below show the maximum load capacity for the Fischer plug in combination with different materials and the maximum bearing capacity for each component for the different signing hanging systems.

DUOPOWER		5 X 25	
HIGHEST RECOMMENDED LOADS ¹⁾ FOR A SINGLE ANCHOR. THE GIVEN LOADS ARE VALID FOR WOOD SCREWS WITH THE SPECIFIED DIAMETER.			
WOOD SCREW DIAMETER	[MM]		4
MIN. EDGE DISTANCE CONCRETE	C _{min} [MM]		30
RECOMMENDED LOADS IN THE RESPECTIVE BASE MATERIAL F _{REC.} ²⁾			
CONCRETE	≥ C20/25	[kN]	0,40
SOLID BRICK	≥ MZ 12	[kN]	0,30
SOLID SAND-LIME BRICK	≥ KS 12	[kN]	0,50
AERATED CONCRETE	≥ AAC 2 (G2)	[kN]	0,05
AERATED CONCRETE	≥ AAC 4 (G4)	[kN]	0,25
VERTICALLY PERFORATED BRICK	≥ HLZ 12 (P ≥ 0.9 KG/DM ³)	[kN]	0,13
PERFORATED SAND-LIME BRICK	≥ KSL 12 (P ≥ 1.6 KG/DM ³)	[kN]	0,40
GYPSUM BLOCK	(P ≥ 0,9 KG/DM ³)	[kN]	0,10
GYPSUM FIBREBOARD	12.5 MM	[kN]	0,24
GYPSUM PLASTERBOARD	12.5 MM	[kN]	0,12
GYPSUM PLASTERBOARD	2 X 12.5 MM	[kN]	0,13
MATTONE FORATO TYP F8		[kN]	0,30
TRAMEZZA DOPPIO UNI 19		[kN]	0,15
SEPA PARPAING		[kN]	0,30

¹⁾ REQUIRED SAFETY FACTORS ARE CONSIDERED.

²⁾ VALID FOR TENSILE LOAD, SHEAR LOAD AND OBLIQUE LOAD UNDER ANY ANGLE.

³⁾ LOAD DETERMINATION ON PLASTERED WALL.



ART. NO.	DESCRIPTION	MAX. CAPACITY
7805.052	LOOP HANGER 1,0 MM - 1,5 MM	10 KG
7807.060	SUSPENSION BRACKET XPO RAIL 1,2 MM	15 KG
7807.200	STEELWIRE + SLIDER 1,2 MM 300 CM BLACK	15 KG
7807.210	STEELWIRE + SLIDER 1,2 MM 300 CM NICKEL	15 KG
7807.100	CEILING BRACKET BLACK CO1BL	15 KG
7807.110	CEILING BRACKET NICKEL CO1NI	15 KG
7807.140	CEILING SUSPENSION 1,2 MM CSO1NI	15 KG
7807.150	CEILING BRACKET AUTO GRIP 1,2 MM DO1BL BLACK	15 KG
7807.160	CEILING BRACKET AUTO GRIP 1,2 MM DO1NI NICKEL	15 KG
7807.350	STEELWIRE 7X7 1,2 MM 10 M	15 KG
7807.360	STEELWIRE BLACK 7X7 1,2 MM 3 M	15 KG
7807.120	RECESSED CEILING CLIP 24 MM WHITE	5 KG
7807.121	RECESSED CEILING CLIP 24 MM BLACK	5 KG
7807.125	RECESSED CEILING CLIP ECO WHITE	1 KG
7807.126	RECESSED CEILING CLIP ECO BLACK	1 KG
7807.130	RECESSED CEILING CLIP 20 MM + SUSPENSION AUTO GRIP 1,2 MM	5 KG
7807.135	DROP CEILINGHANGER	4 KG
7807.310	STEELWIRE + HOOK 1,2 MM 300 CM	15 KG
7807.010	STEELWIRE HOOK AUTO GRIP 1,2 MM STO1BL	15 KG
7807.020	STEELWIRE HOOK AUTO GRIP 1,2 MM STO1NI	15 KG
7807.030	STEELWIRE HOOK AUTO GRIP 1,2 MM STO2NI	15 KG
7807.040	STEELWIRE HOOK AUTO GRIP 1,2 MM STO3NI	15 KG
7807.050	STEELWIRE CLAMPHOOK AUTO GRIP 1,2 MM STCO1NI	15 KG
7807.070	STEELWIRE HOOK AUTO GRIP 1,2 MM STDO1BL BLACK	15 KG
7807.080	STEELWIRE HOOK AUTO GRIP 1,2 MM STDO1NI NICKEL	15 KG
7807.400	ACOUSTIC SPRING O1-NI	5 KG
7807.560	DROP CEILING CLIPPHANGER WHITE	4 KG
7807.561	DROP CEILING CLIPPHANGER BLACK	4 KG
9.4404	PERLON 2 MM COIL 100 M	15 KG
9.4421S	PERLON 2 MM COIL 500 M	15 KG
9.4431	WIRE CLAMP 2 MM ALU	15 KG





ARTITEQ
HERASTRAAT 39
5047 TX TILBURG
THE NETHERLANDS
T +31 (0)13 572 90 70
INFO@ARTITEQ.COM
WWW.ARTITEQ.COM

EN

2701