

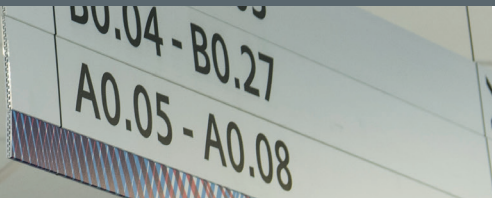

SIGNALÉTIQUE



SIGNALÉTIQUE

En tant que spécialiste des produits dans le domaine des concepts d'accrochage, Artiteq développe depuis 1995 des systèmes d'accrochage flexibles pour les tableaux, le matériel de présentation et la signalétique dans un bâtiment à Tilburg (NL).

En plus de sa gamme principale de cimaises pour tableaux, Artiteq propose une gamme diversifiée dans le domaine de la signalétique. Pour une suspension sûre et correcte des panneaux, des enseignes et de la signalétique à l'intérieur d'un bâtiment. Dans les écoles, les hôpitaux et les (grands) immeubles de bureaux, par exemple, il est important que les salles de classe, les voies d'évacuation, les toilettes et les sols soient correctement indiqués. En tant que spécialiste de l'accrochage, Artiteq propose plusieurs produits de signalétique permettant d'accrocher les panneaux de manière simple et appropriée.

Dans cette brochure, nous expliquons les produits et présentons la gamme de produits. Le choix du système dépend de la situation, de l'endroit où il sera accroché et du type de plafond ou de mur.

PROFESSIONAL
SAFE
FLEXIBLE





PLAFOND
▶ 4

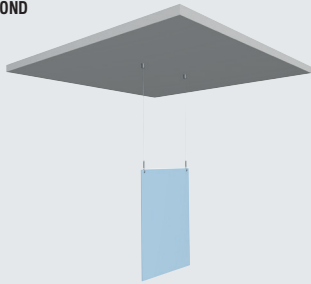

PLAFOND MURAL INCLINÉ
▶ 5

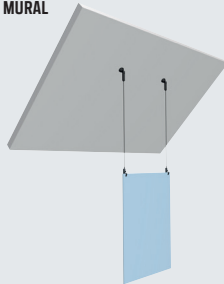

PLAFOND ACOUSTIQUE
▶ 6

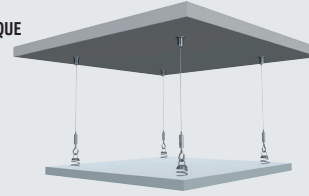

FAUX PLAFOND
▶ 7

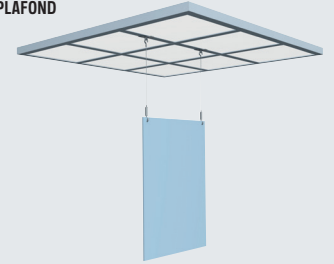

XPO RAIL
▶ 8

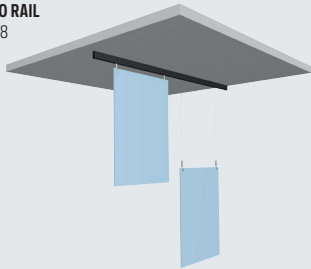

XPO RAIL SUSPENSION LIBRE
▶ 9

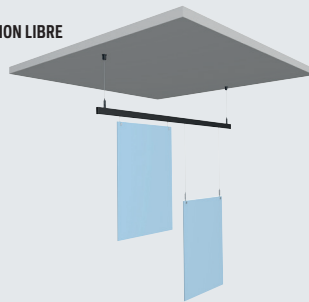

LOOP HANGER
▶ 10

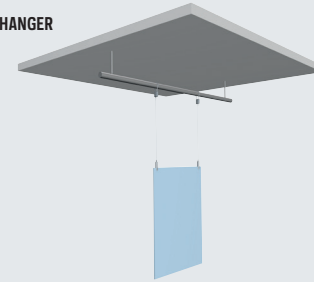

FAUX PLAFOND CLIP
▶ 11



CLIP DE SUSPENSION FAUX PLAFOND
▶ 12



SUSPENSION FAUX PLAFOND
▶ 13



A

A1			A2			A3
ATTACHE PLAFOND NOIR CO1BL	FISCHER DUOPOWER 5 X 25 5 MM	3,5 X 40 MM	ATTACHE PLAFOND NICKELÉ CO1NI	FISCHER DUOPOWER 5 X 25 5 MM	3,5 X 40 MM	SUSPENSION PLAFOND AUTO BLOQUANT 1,2 MM CS01NI
7807.100	9.4934	9.4945	7807.110	9.4934	9.4945	7807.140

B

B1	B2	B3	B4
FIL EN ACIER + CYLINDRE 1,2 MM 300 CM NOIR	FIL EN ACIER + CYLINDRE 1,2 MM 300 CM NICKELÉ	FIL EN ACIER 7 X 7 1,2 MM 10 M*	FIL EN ACIER NOIR 7 X 7 1,2 MM 3 M*
7807.200	7807.210	7807.350	7807.360

C

C1	C2	C3	C4	C5	C6	C7
CROCHET AUTO BLOQUANT FIL EN ACIER 1,2 MM ST01BL	CROCHET AUTO BLOQUANT FIL EN ACIER 1,2 MM ST01NI	CROCHET AUTO BLOQUANT FIL EN ACIER 1,2 MM ST02NI	CROCHET AUTO BLOQUANT FIL EN ACIER 1,2 MM ST03NI	CROCHET ARRÊT AUTO BLOQUANT FIL EN ACIER 1,2 MM STC01NI	CROCHET AUTO BLOQUANT FIL EN ACIER 1,2 MM STD01NI	CROCHET AUTO BLOQUANT FIL EN ACIER 1,2 MM STD01BL
7807.010	7807.020	7807.030	7807.040	7807.050	7807.080	7807.070

D

KIT COMPLET
SET PLAFOND 2X FIL EN ACIER 1,2 MM 300 CM + 2X ATTACHE PLAFOND NICKELÉ + 2X CROCHET AUTO BLOQUANT FIL EN ACIER
7807.520

* COUPE-CÂBLE 7807.900 DISPONIBLE POUR UTILISATION AVEC FIL EN ACIER 7 X 7 1,2 MM

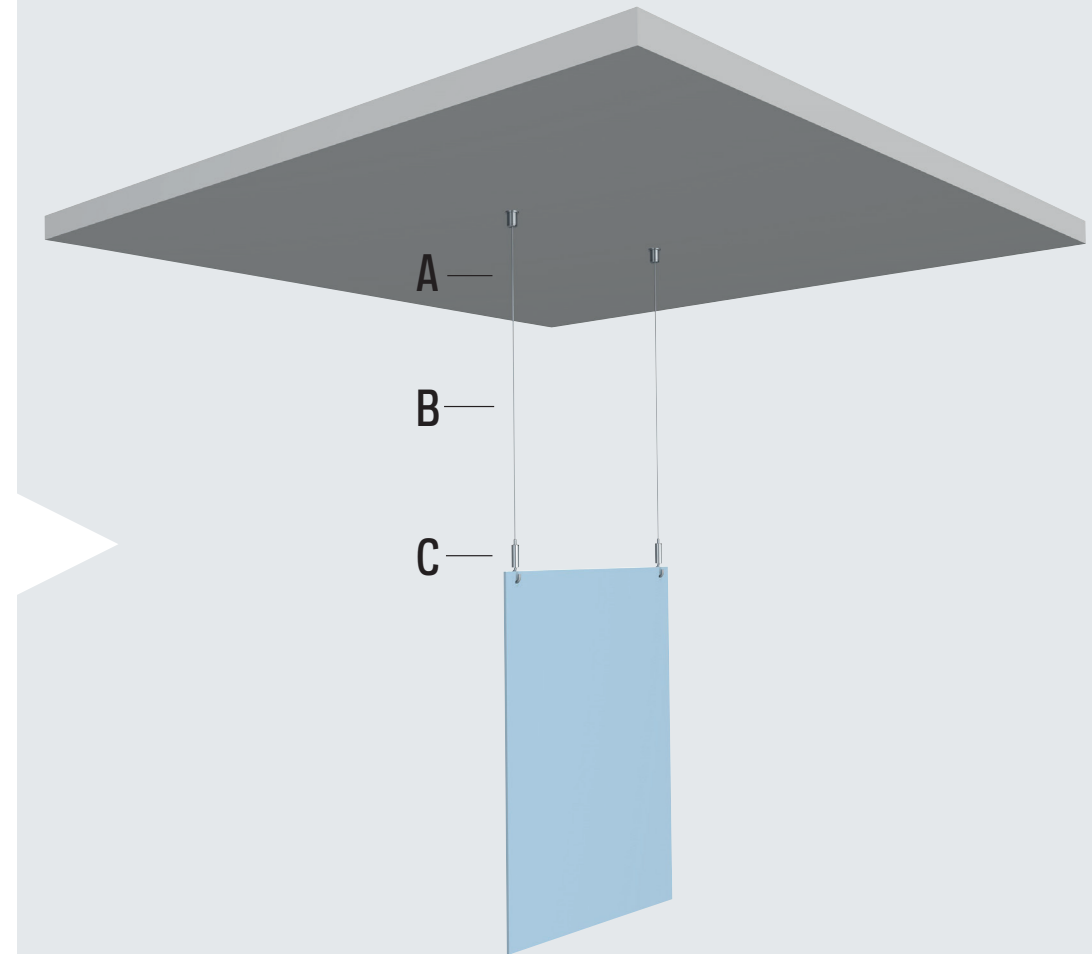

COMBINAISON AFFICHÉE: A2 + B2 + C3

COMBINAISONS POSSIBLES: A1/A2 + B1/B2 + C1/C2/C3/C4/C5/C6/C7
A3 + B3/B4 + C1/C2/C3/C4/C5/C6/C7

► PLAFOND MURAL INCLINÉ





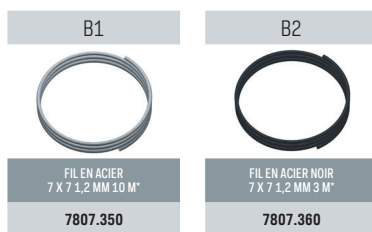

A



B



C

C1	C2	C3	C4	C5	C6	C7
						
CROCHET AUTO BLOQUANT FIL EN ACIER 1,2 MM ST01BL	CROCHET AUTO BLOQUANT FIL EN ACIER 1,2 MM ST01NI	CROCHET AUTO BLOQUANT FIL EN ACIER 1,2 MM ST02NI	CROCHET AUTO BLOQUANT FIL EN ACIER 1,2 MM ST03NI	CROCHET ARRÊT AUTO BLOQUANT FIL EN ACIER 1,2 MM STC01NI	CROCHET AUTO BLOQUANT FIL EN ACIER 1,2 MM STD01NI	CROCHET AUTO BLOQUANT FIL EN ACIER 1,2 MM STD01BL
7807.010	7807.020	7807.030	7807.040	7807.050	7807.080	7807.070

* COUPE-CÂBLE 7807.900 DISPONIBLE POUR UTILISATION AVEC FIL EN ACIER 7 x 7 1,2 MM

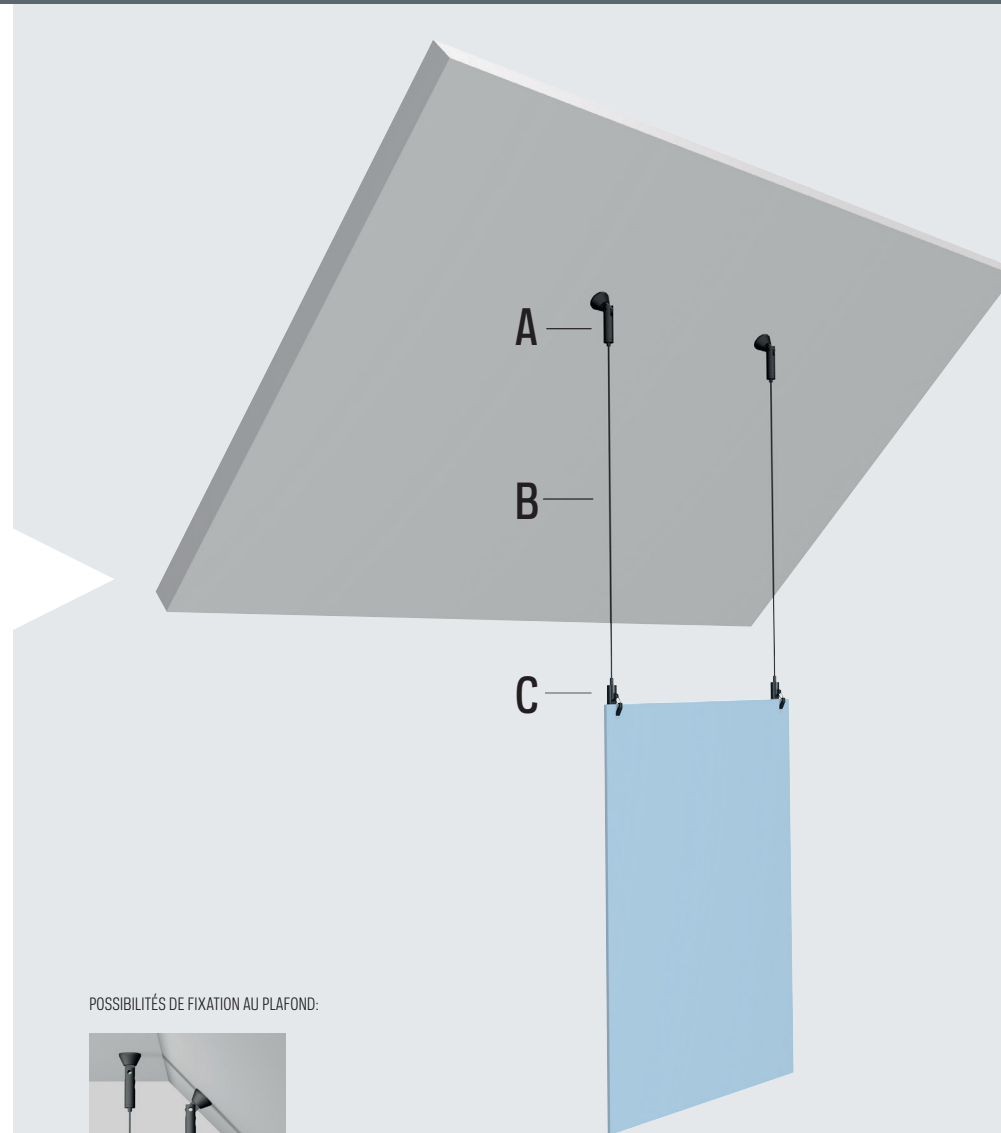







POSSIBILITÉS DE FIXATION AU PLAFOND:











COMBINAISON AFFICHÉE: A2 + B2 + C1

COMBINAISONS POSSIBLES: A1/A2 + B1/B2 + C1/C2/C3/C4/C5/C6/C7

▶ PLAFOND ACOUSTIQUE

A1			A2			A3
						
ATTACHE PLAFOND NOIR CO1BL	FISCHER DUOPOWER 5 X 25 5 MM	VIS 3,5 X 40 MM	ATTACHE PLAFOND NICKELÉ CO1NI	FISCHER DUOPOWER 5 X 25 5 MM	VIS 3,5 X 40 MM	SUSPENSION PLAFOND AUTO BLOQUANT 1,2 MM CSO1NI
7807.100	9.4934	9.4945	7807.110	9.4934	9.4945	7807.140

B1	B2	B3	B4
			
FIL EN ACIER + CYLINDRE 1,2 MM 300 CM NOIR	FIL EN ACIER + CYLINDRE 1,2 MM 300 CM NICKELÉ	FIL EN ACIER 7 X 7 1,2 MM 10 M*	FIL EN ACIER NOIR 7 X 7 1,2 MM 3 M*
7807.200	7807.210	7807.350	7807.360

C1	C2	C3	C4
			
CROCHET AUTO BLOQUANT FIL EN ACIER 1,2 MM ST01BL	CROCHET AUTO BLOQUANT FIL EN ACIER 1,2 MM ST01NI	CROCHET AUTO BLOQUANT FIL EN ACIER 1,2 MM ST02NI	CROCHET AUTO BLOQUANT FIL EN ACIER 1,2 MM ST03NI
7807.010	7807.020	7807.030	7807.040

D

RESSORT ACOUSTIQUE 01-NI
7807.400

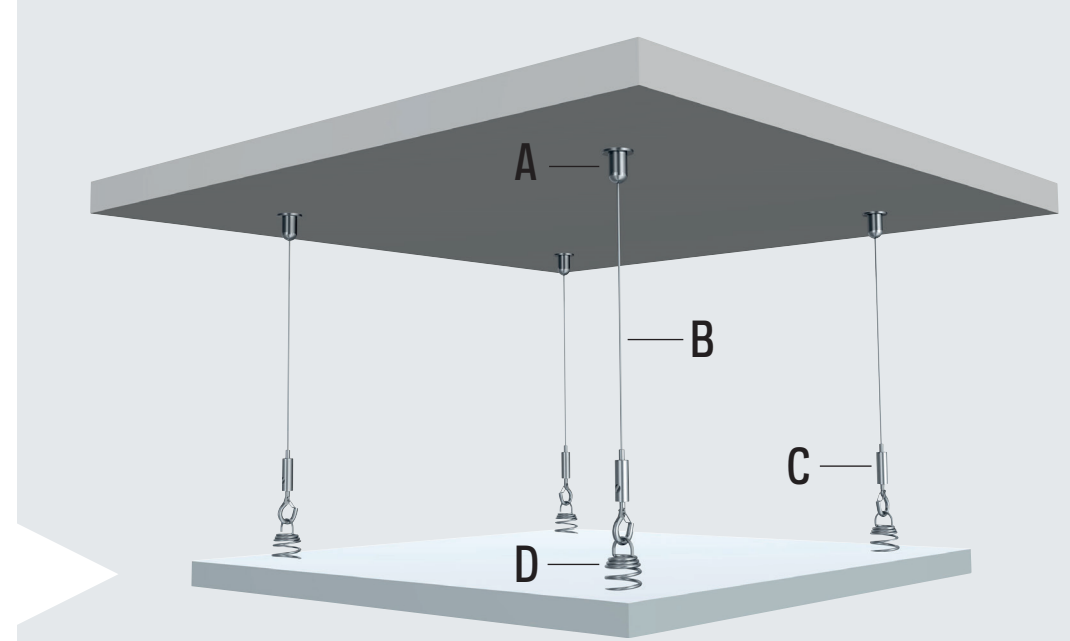

* COUPE-CÂBLE 7807.900 DISPONIBLE POUR UTILISATION AVEC FIL EN ACIER 7 X 7 1,2 MM













COMBINAISON AFFICHÉE: A2 + B2 + C4 + D

COMBINAISONS POSSIBLES: A1/A2 + B1/B2 + C1/C2/C3/C4 + D
A3 + B3/B4 + C1/C2/C3/C4 + D

► FAUX PLAFOND

A1	A2	A3
		
ATTACHE FAUX PLAFOND 24 MM	ATTACHE FAUX PLAFOND 24 MM + SUSPENSION AUTO BLOQUANT 1,2 MM	ATTACHE FAUX PLAFOND NOIR 24 MM
7807.120	7807.130	7807.121

B1	B2	B3
		
FIL EN ACIER + CROCHET 1,2 MM 300 CM	FIL EN ACIER 7 X 7 1,2 MM 10 M*	FIL EN ACIER NOIR 7 X 7 1,2 MM 3 M*
7807.310	7807.350	7807.360

C1	C2	C3	C4	C5	C6	C7
						
CROCHET AUTO BLOQUANT FIL EN ACIER 1,2 MM ST01BL	CROCHET AUTO BLOQUANT FIL EN ACIER 1,2 MM ST01NI	CROCHET AUTO BLOQUANT FIL EN ACIER 1,2 MM ST02NI	CROCHET AUTO BLOQUANT FIL EN ACIER 1,2 MM ST03NI	CROCHET ARRÊT AUTO BLOQUANT FIL EN ACIER 1,2 MM STC01NI	CROCHET AUTO BLOQUANT FIL EN ACIER 1,2 MM STD01NI	CROCHET AUTO BLOQUANT FIL EN ACIER 1,2 MM STD01BL
7807.010	7807.020	7807.030	7807.040	7807.050	7807.080	7807.070

COMPLETE SET

SET FAUX PLAFOND 2X FIL EN ACIER 1,2 MM 300 CM + 2X ATTACHE FAUX PLAFOND + 2X CROCHET AUTO BLOQUANT FIL EN ACIER
7807.510

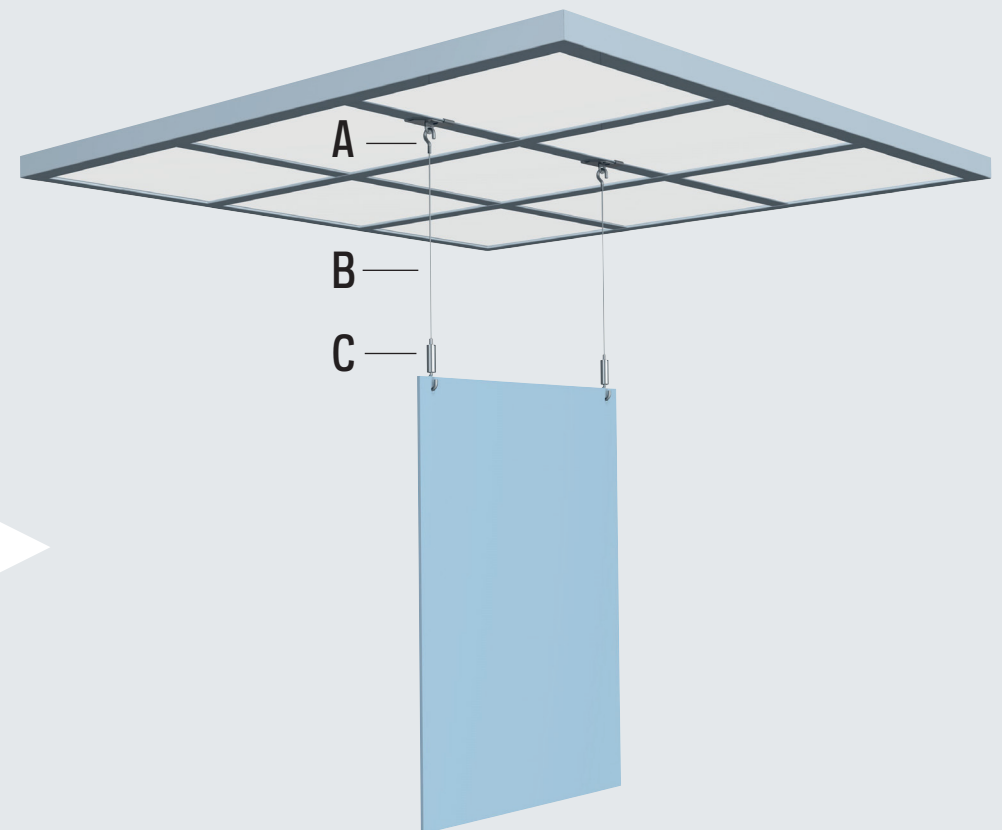
* COUPE-CÂBLE 7807.900 DISPONIBLE POUR UTILISATION AVEC FIL EN ACIER 7 X 7 1,2 MM



COMBINAISON AFFICHÉE: A1 + B1 + C3

COMBINAISONS POSSIBLES: A1 + B1 + C1/C2/C3/C4/C5/C6/C7
A2 + B2/B3 + C1/C2/C3/C4/C5/C6/C7

▶ XPO RAIL

A

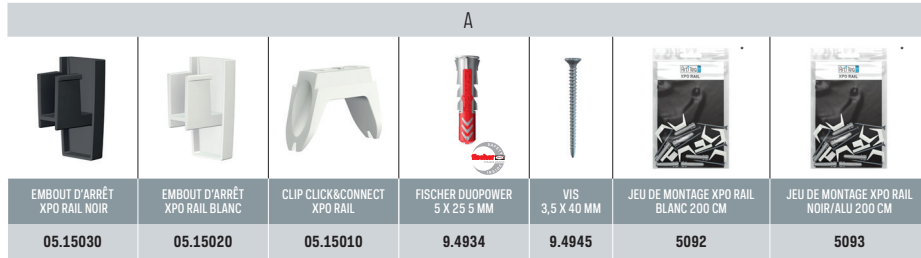
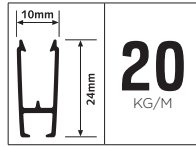
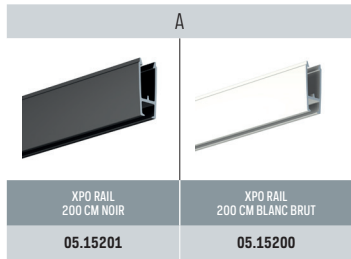

B

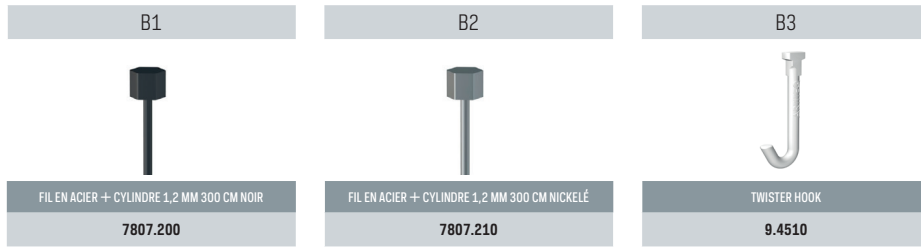

C

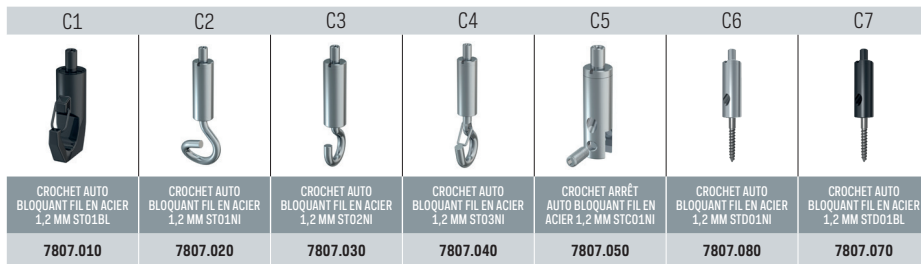

* CONTENU JEU DE MONTAGE



		QUANTITÉ 200 CM
05.15010	CLIP XPO RAIL	6x
9.4934	CHEVILLE FISCHER 5 MM	6x
9.4945	VIS POUR CHEVILLE FISCHER 5 MM	6x
05.15020 / 05.15030	EMBOÛT XPO RAIL BLANC / NOIR	2x
2639	INSTRUCTION	1x

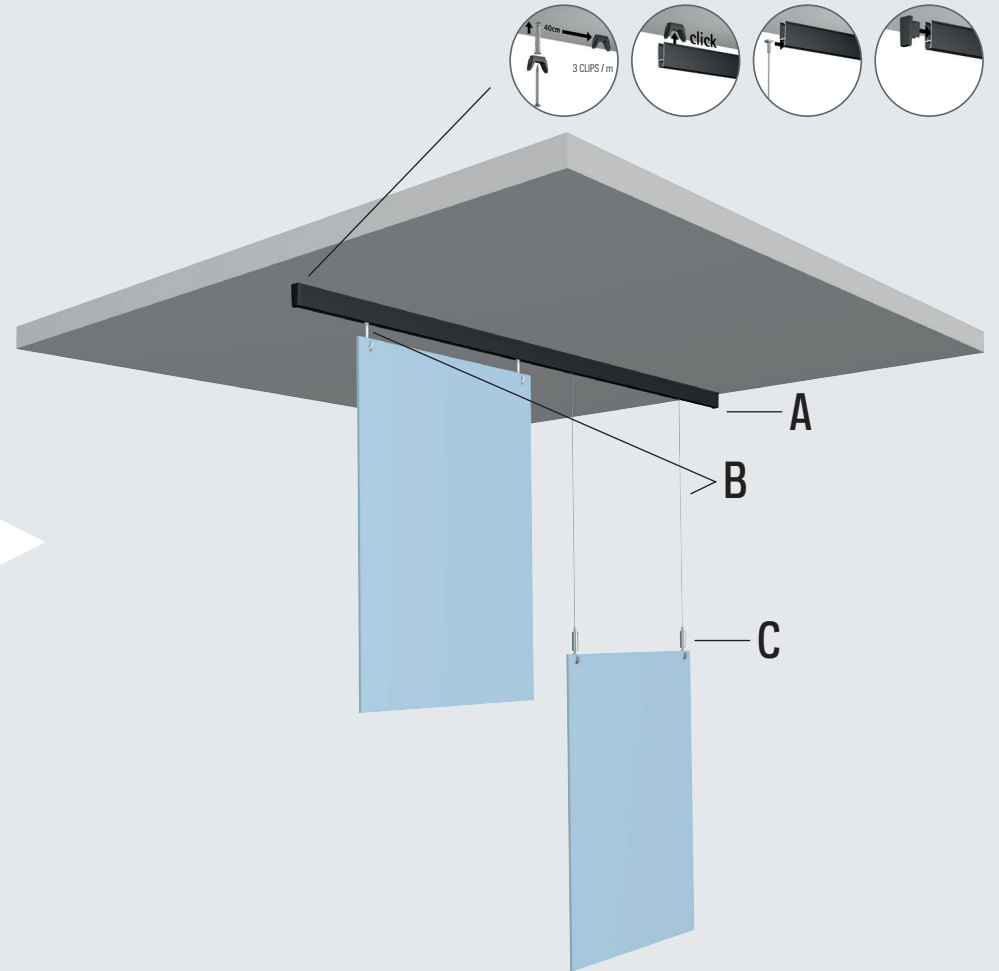

COMBINAISON AFFICHÉE: A + B3
A + B2 + C3

COMBINAISONS POSSIBLES: A + B1/B2 + C1/C2/C3/C4/C5/C6/C7
A + B3

▶ XPO RAIL SUSPENSION LIBRE

A1			A2			A3
ATTACHE PLAFOND NOIR CO1BL	FISCHER DUOPOWER 5 X 25 5 MM	VIS	ATTACHE PLAFOND NICKELÉ CO1NI	FISCHER DUOPOWER 5 X 25 5 MM	VIS	SUSPENSION PLAFOND AUTO BLOQUANT 1,2 MM CS01NI
7807.100	9.4934	9.4945	7807.110	9.4934	9.4945	7807.140

B1	B2	B3	B4
FIL EN ACIER + CYLINDRE 1,2 MM 300 CM NOIR	FIL EN ACIER + CYLINDRE 1,2 MM 300 CM NICKELÉ	FIL EN ACIER 7 X 7 1,2 MM 10 M*	FIL EN ACIER NOIR 7 X 7 1,2 MM 3 M*
7807.200	7807.210	7807.350	7807.360

C		
SUPPORT D'ATTACHE XPO RAIL 1,2 MM	XPO RAIL 200 CM NOIR	EMBOUT D'ARRÊT XPO RAIL NOIR
7807.060	05.15201	05.15030

D1	D2	D3
FIL EN ACIER + CYLINDRE 1,2 MM 300 CM NOIR	FIL EN ACIER + CYLINDRE 1,2 MM 300 CM NICKELÉ	TWISTER HOOK
7807.200	7807.210	9.4510

E1	E2	E3	E4	E5	E6	E7
CROCHET AUTO BLOQUANT FIL EN ACIER 1,2 MM ST01BL	CROCHET AUTO BLOQUANT FIL EN ACIER 1,2 MM ST01NI	CROCHET AUTO BLOQUANT FIL EN ACIER 1,2 MM ST02NI	CROCHET AUTO BLOQUANT FIL EN ACIER 1,2 MM ST03NI	CROCHET ARRÊT AUTO BLOQUANT FIL EN ACIER 1,2 MM STC01NI	CROCHET AUTO BLOQUANT FIL EN ACIER 1,2 MM STD01NI	CROCHET AUTO BLOQUANT FIL EN ACIER 1,2 MM STD01BL
7807.010	7807.020	7807.030	7807.040	7807.050	7807.080	7807.070

* COUPE-CÂBLE 7807.900 DISPONIBLE POUR UTILISATION AVEC FIL EN ACIER 7 X 7 1,2 MM

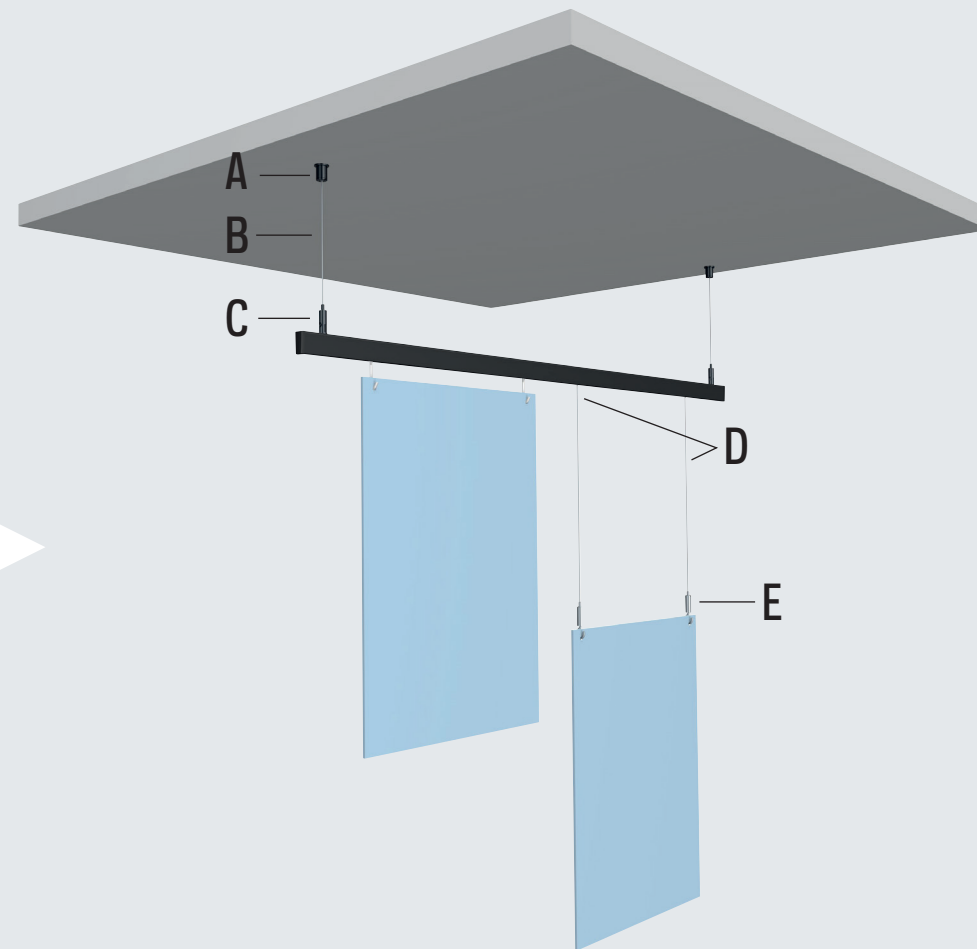

COMBINAISON AFFICHÉE: A1+B2+C+D2+E3 / A1+BD+C+D3

COMBINAISONS POSSIBLES: A1/A2 + B1/B2 + C + D1/D2 + E1/E2/E3/E4/E5/E6/E7
 A1/A2 + B1/B2 + C + D3
 A3 + B3/B4 + C + D1/D2 + E1/E2/E3/E4/E5/E6/E7
 A3 + B3/B4 + C + D3

▶ LOOP HANGER

A



B

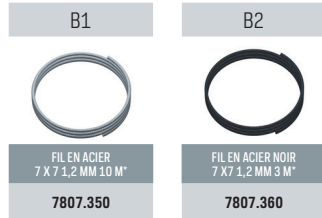

C

C1	C2	C3	C4	C5	C6	C7
CROCHET AUTO BLOQUANT FIL EN ACIER 1,2 MM STD1BL	CROCHET AUTO BLOQUANT FIL EN ACIER 1,2 MM STD1NI	CROCHET AUTO BLOQUANT FIL EN ACIER 1,2 MM STD2NI	CROCHET AUTO BLOQUANT FIL EN ACIER 1,2 MM STD3NI	CROCHET ARRÊT AUTO BLOQUANT FIL EN ACIER 1,2 MM STD01NI	CROCHET AUTO BLOQUANT FIL EN ACIER 1,2 MM STD01NI	CROCHET AUTO BLOQUANT FIL EN ACIER 1,2 MM STD01BL
7807.010	7807.020	7807.030	7807.040	7807.050	7807.080	7807.070

D

KIT COMPLET 1	KIT COMPLET 2
KIT DE SUSPENSION LOOP HANGER + CROCHET 300 CM	KIT DE SUSPENSION LOOP HANGER + OUILLET 300 CM
7840.300	7840.310

* COUPE-CÂBLE 7807.900 DISPONIBLE POUR UTILISATION AVEC FIL EN ACIER 7 X 7 1,2 MM

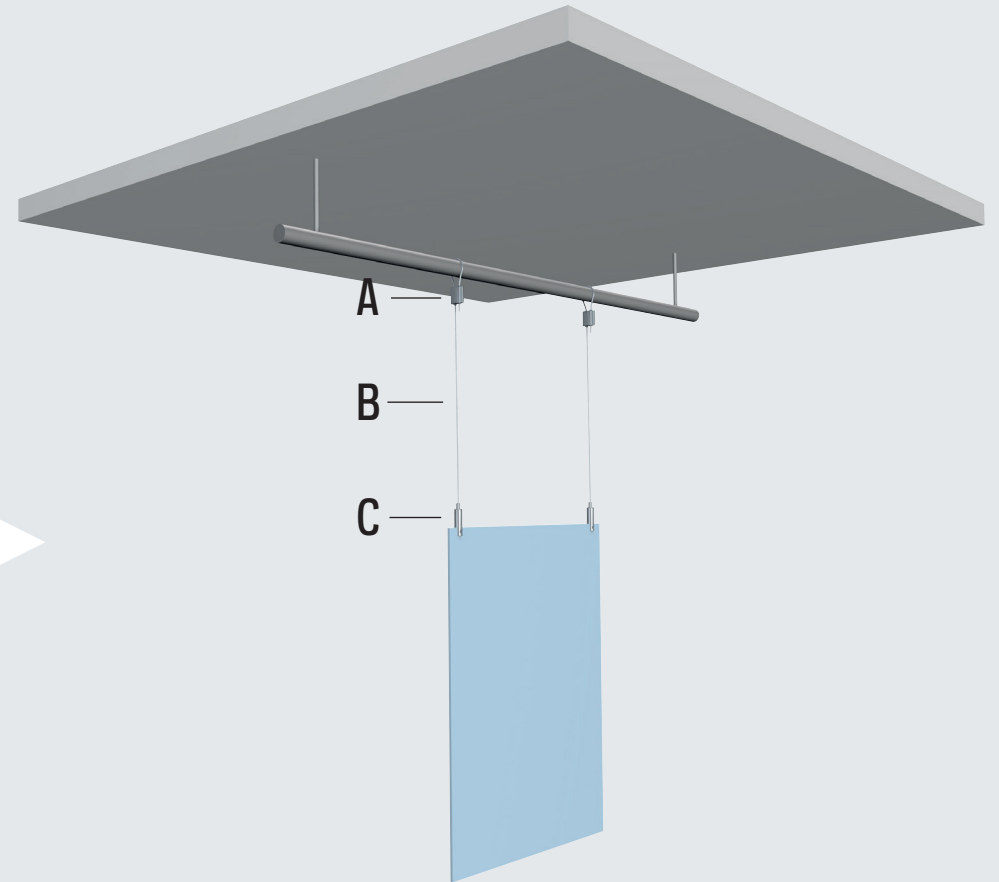

COMBINAISON AFFICHÉE: A + B1 + C5





COMBINAISONS POSSIBLES: A + B1/B2 + C1/C2/C3/C4/C5/C6/C7

► FAUX PLAFOND CLIP

A

A1	A2
	
FAUX PLAFOND ECO CLIP (MAX. 1KG)	PAGE 69 2 DAYS AGO REPLY (MAX. 1KG)
7807.125	7807.126

B

B1	B2	B3	B4
			
TWISTER 1 MM PERLON	TWISTER 2 MM PERLON	SLIDER ECONOMY 2 MM PERLON	BOBINE DE FIL EN PERLON 2 MM
30.21150 150 CM	09.23100 100 CM	9.4424 100 CM	9.4404 100 CM
30.21200 200 CM	09.23150 150 CM	9.4425 150 CM	9.4421S 500 CM
30.21300 300 CM	09.23200 200 CM	9.4426 200 CM	SERRE-CÂBLE 2 MM ALU
	09.23250 250 CM	9.4427 250 CM	9.4431
	09.23300 300 CM	9.4428 300 CM	
	09.23500 500 CM		

C

C1	C2
	
AUTO GRIP	MINI CROCHET
30.41100	9.4205

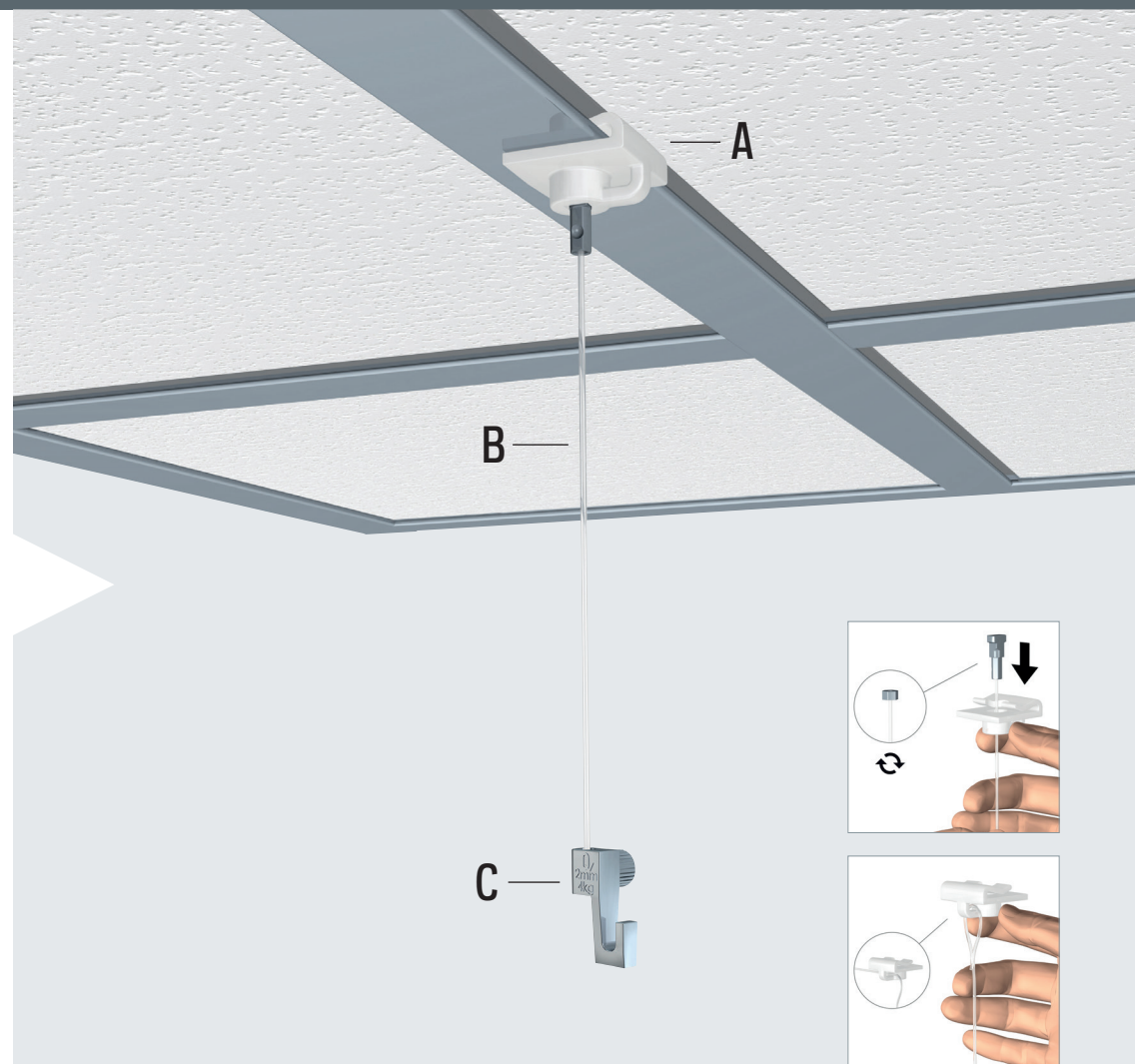

COMBINAISON AFFICHÉE: A1 + B2 + C2

COMBINAISONS POSSIBLES:
 A1 + B3 + C2
 A1 + B2 + C2
 A1 + B1 + C1
 A1 + B4 + C2

▶ CLIP DE SUSPENSION FAUX PLAFOND

KIT COMPLET

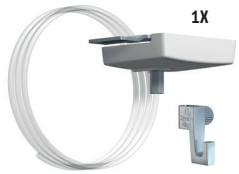

1X

KIT CLIP DE SUSPENSION FAUX PLAFOND BLAN
1X 200 CM FIL DE PERLON
+ MINI CROCHET 4 KG

7807.560



1X

KIT CLIP DE SUSPENSION FAUX PLAFOND NOIR
1X 200 CM FIL DE PERLON
+ MINI CROCHET 4 KG

7807.561

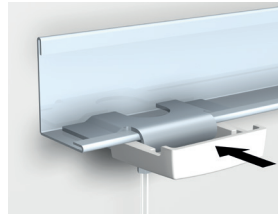
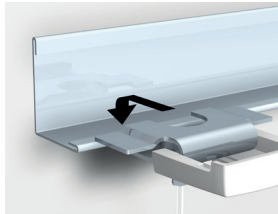

MAX

4

KG/M

10

ANS
DE GARANTIE



► SUSPENSION FAUX PLAFOND

SUSPENSION FAUX PLAFOND



SUSPENSION FAUX PLAFOND

7807.135

FILS DE SUSPENSION



9.4424 SLIDER ECONOMY

9.4425 SLIDER ECONOMY

9.4426 SLIDER ECONOMY

9.4427 SLIDER ECONOMY

9.4428 SLIDER ECONOMY

CROCHET



9.4205 4 KG MANUEL



MAX

4

KG/M

10

ANS
DE GARANTIE

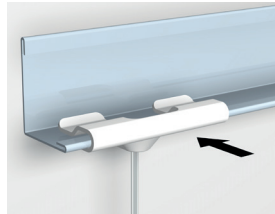
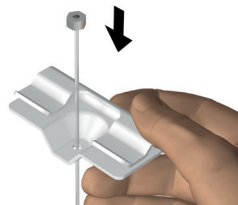

Artiteq a opté pour la cheville Fischer UX 5x30 R en combinaison avec ses systèmes de suspension. La cheville Fischer UX 5x30 R s'utilise sur différents types de matériaux, comme du béton, de la pierre et du plâtre. Selon le matériau, la cheville supporte une charge maximale de **30 kg**. La perceuse doit avoir un diamètre de 5 mm. La cheville a une longueur de 30 mm. La vis à utiliser en combinaison avec la cheville a une longueur de 38 mm et un diamètre de 3,5 mm (à utiliser avec un embout PZ2).

Pour déterminer la charge maximale d'un système de suspension signalétique, il est indispensable de connaître les matériaux de fixation utilisés, et la base (le type de matériaux) sur laquelle il est fixé. Les composants du système de suspension signalétique ont tous une capacité de charge maximale. Il s'agit de la capacité de charge maximale de l'élément même, et non pas de celle qui doit être prise en compte pour le système total. Pour le système total, la capacité de charge précisée pour le matériau de fixation en combinaison avec le type de matériau auquel il est fixé est **déterminante**.

Pour chaque système de suspension signalétique, il s'agit d'adapter le poids à suspendre à la capacité de charge maximale du matériau de fixation. Si les systèmes sont accrochés à d'autres parties suspendues comme par exemple des faux plafonds, vous devez connaître la capacité de charge maximale de cet élément suspendu avant d'utiliser nos systèmes. Vous trouverez dans les tableaux ci-après la capacité de charge maximale pour la cheville Fischer en combinaison avec différents matériaux et la capacité de charge maximale par élément pour différents systèmes de suspension de signalétique.

DUOPOWER		5 X 25	
HIGHEST RECOMMENDED LOADS ¹⁾ FOR A SINGLE ANCHOR. THE GIVEN LOADS ARE VALID FOR WOOD SCREWS WITH THE SPECIFIED DIAMETER.			
WOOD SCREW DIAMETER		[MM]	4
MIN. EDGE DISTANCE CONCRETE		C _{min} [MM]	30
RECOMMENDED LOADS IN THE RESPECTIVE BASE MATERIAL F _{REC.} ²⁾			
CONCRETE	≥ C20/25	[kN]	0,40
SOLID BRICK	≥ MZ 12	[kN]	0,30
SOLID SAND-LIME BRICK	≥ KS 12	[kN]	0,50
AERATED CONCRETE	≥ AAC 2 (G2)	[kN]	0,05
AERATED CONCRETE	≥ AAC 4 (G4)	[kN]	0,25
VERTICALLY PERFORATED BRICK	≥ HLZ 12 (P ≥ 0,9 KG/DM ³)	[kN]	0,13
PERFORATED SAND-LIME BRICK	≥ KSL 12 (P ≥ 1,6 KG/DM ³)	[kN]	0,40
GYPHUM BLOCK	(P ≥ 0,9 KG/DM ³)	[kN]	0,10
GYPHUM FIBREBOARD	12,5 MM	[kN]	0,24
GYPHUM PLASTERBOARD	12,5 MM	[kN]	0,12
GYPHUM PLASTERBOARD	2 X 12,5 MM	[kN]	0,13
MATTONE FORATO TYP F8		[kN]	0,30
TRAMEZZA DOPPIO UNI 19		[kN]	0,15
SEPA PARPAING		[kN]	0,30

¹⁾ REQUIRED SAFETY FACTORS ARE CONSIDERED.

²⁾ VALID FOR TENSILE LOAD, SHEAR LOAD AND OBLIQUE LOAD UNDER ANY ANGLE.

³⁾ LOAD DETERMINATION ON PLASTERED WALL.



ART. NO.	DESCRIPTION	MAX. CAPACITY
7805.052	LOOP HANGER 1,0 MM - 1,5 MM	10 KG
7807.060	SUSPENSION BRACKET XPO RAIL 1,2 MM	15 KG
7807.200	STEELWIRE + SLIDER 1,2 MM 300 CM BLACK	15 KG
7807.210	STEELWIRE + SLIDER 1,2 MM 300 CM NICKEL	15 KG
7807.100	CEILING BRACKET BLACK CO1BL	15 KG
7807.110	CEILING BRACKET NICKEL CO1NI	15 KG
7807.140	CEILING SUSPENSION 1,2 MM CSO1NI	15 KG
7807.150	CEILING BRACKET AUTO GRIP 1,2 MM DO1BL BLACK	15 KG
7807.160	CEILING BRACKET AUTO GRIP 1,2 MM DO1NI NICKEL	15 KG
7807.350	STEELWIRE 7X7 1,2 MM 10 M	15 KG
7807.360	STEELWIRE BLACK 7X7 1,2 MM 3 M	15 KG
7807.120	RECESSED CEILING CLIP 24 MM WHITE	5 KG
7807.121	RECESSED CEILING CLIP 24 MM BLACK	5 KG
7807.125	RECESSED CEILING CLIP ECO WHITE	1 KG
7807.126	RECESSED CEILING CLIP ECO BLACK	1 KG
7807.130	RECESSED CEILING CLIP 20 MM + SUSPENSION AUTO GRIP 1,2 MM	5 KG
7807.135	DROP CEILINGHANGER	4 KG
7807.310	STEELWIRE + HOOK 1,2 MM 300 CM	15 KG
7807.010	STEELWIRE HOOK AUTO GRIP 1,2 MM STO1BL	15 KG
7807.020	STEELWIRE HOOK AUTO GRIP 1,2 MM STO1NI	15 KG
7807.030	STEELWIRE HOOK AUTO GRIP 1,2 MM STO2NI	15 KG
7807.040	STEELWIRE HOOK AUTO GRIP 1,2 MM STO3NI	15 KG
7807.050	STEELWIRE CLAMPHOOK AUTO GRIP 1,2 MM STCO1NI	15 KG
7807.070	STEELWIRE HOOK AUTO GRIP 1,2 MM STDO1BL BLACK	15 KG
7807.080	STEELWIRE HOOK AUTO GRIP 1,2 MM STDO1NI NICKEL	15 KG
7807.400	ACOUSTIC SPRING O1-NI	5 KG
7807.560	DROP CEILING CLIPPHANGER WHITE	4 KG
7807.561	DROP CEILING CLIPPHANGER BLACK	4 KG
9.4404	PERLON 2 MM COIL 100 M	15 KG
9.4421S	PERLON 2 MM COIL 500 M	15 KG
9.4431	WIRE CLAMP 2 MM ALU	15 KG





ARTITEQ
HERASTRAAT 39
5047 TX TILBURG
PAYS-BAS
T +31 (0)13 572 90 70
INFO@ARTITEQ.COM
WWW.ARTITEQ.COM

FR