

▶ FRAME ACCESSORIES



SIMPLE
SAFE
STRONG

Credits: @rohouseproud

ARTITEQ BACK FRAME HANGING SYSTEM



A **safe** and **solid** solution to hang printed panels.
 Adds **depth** and **shadow** between panel and wall.
 Adds **rigidity** to **flexible** panels made of aluminium (Dibond), forex or acrylic.

The Back Frame Hanging System is a mounting system especially for thin and flexible panels made of aluminium, forex or acrylic. It helps to stiffen the panel, while mounting is easy and safe. The leveling system provided by the Back Frame Corners is particularly convenient for the mounted panel allowing adjustment for the panel up to 6 mm. The panel will always be straight without drilling new holes.

The Back Frame Hanging System is available in 8 mm and 15 mm profiles, both in the versions alu mill finish and silver anodised.

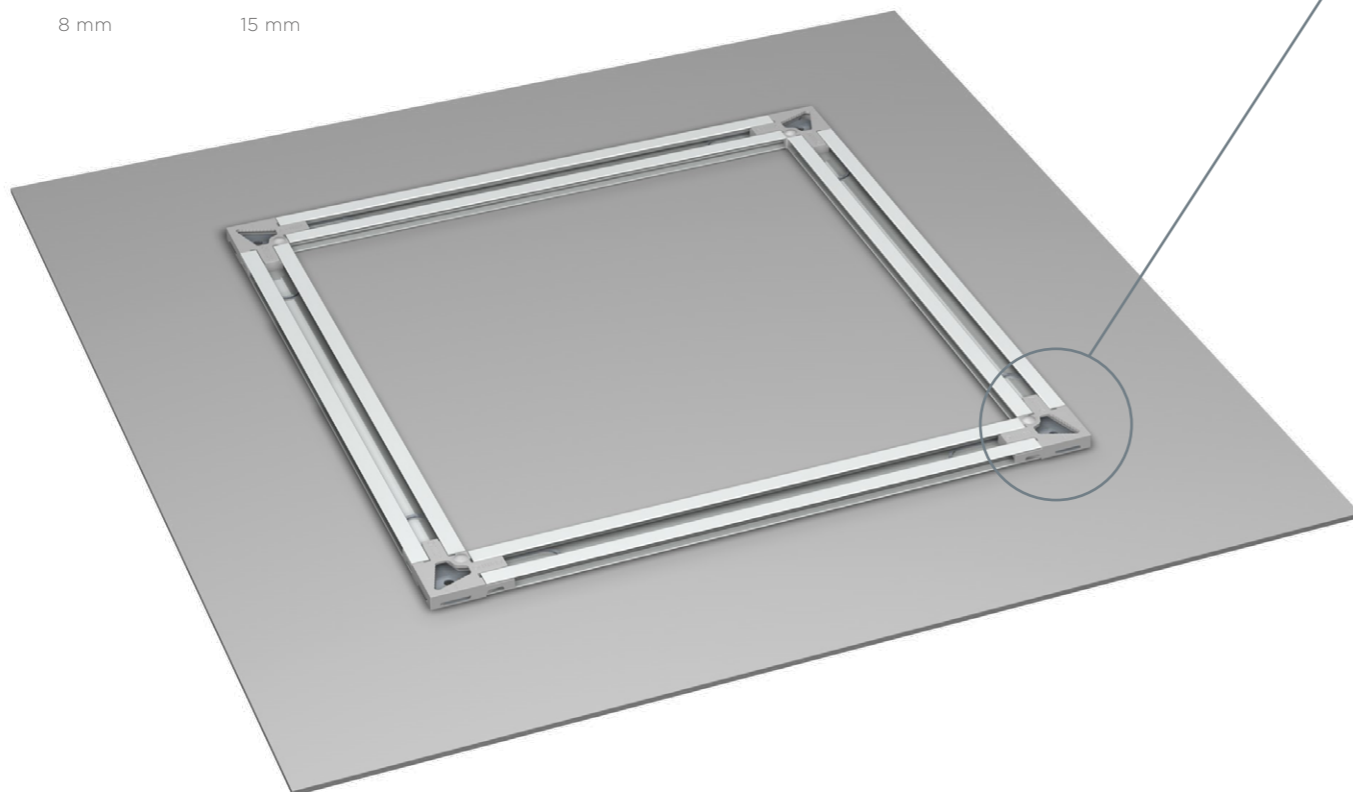
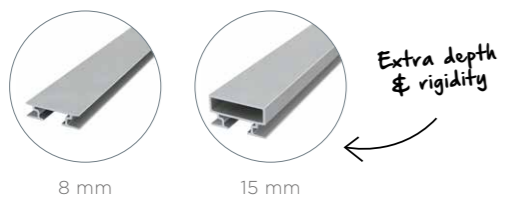

ARTITEQ BACK FRAME HANGING SYSTEM



1. WALL PROTECTION INCORPORATED

Wall protection is incorporated in the Power Corners.

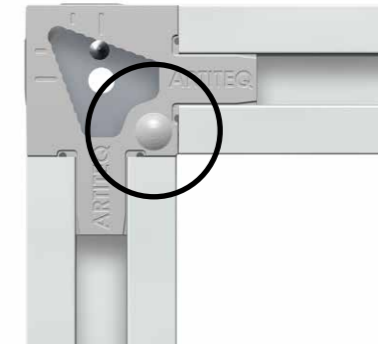

2. LESS TAPE, BETTER LOAD CAPACITY

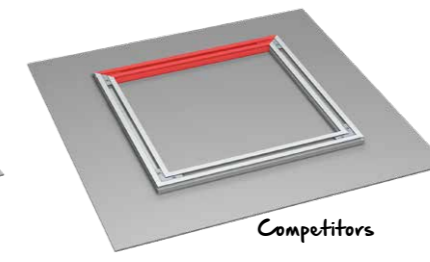
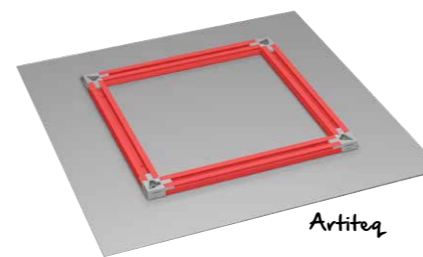

Rigid fixing thanks to steel spring!



Power Corners enable equal weight distribution because of rigid fixing thanks to steel spring in square-cut profiles instead of mitre-cut profiles.

3. EASY HANGING: 3 OPTIONS

The Artiteq Back Frame Power Corners provide 3 easy ways of hanging a printed panel : Fixed (1), Secured (2) and Flexible (3).

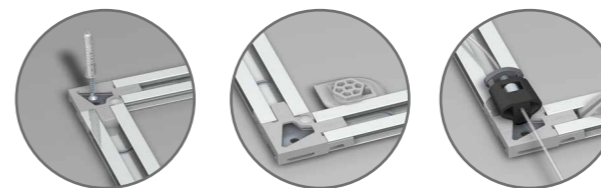

4. NO EXTRA ACCESSORIES NEEDED

The printed panel is hung using the Power Corners, no extra accessories needed.

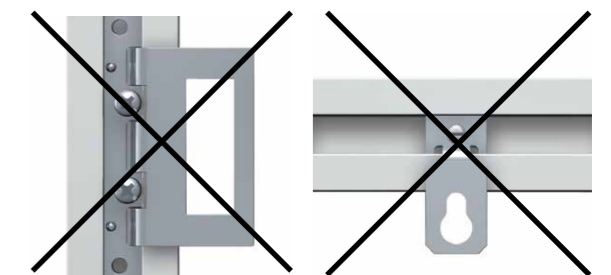

ARTITEQ BACK FRAME HANGING SYSTEM



The Back Frame Hanging System is available in 8 mm and 15 mm profiles, both in the versions alu mill finish and silver anodised.

BACK FRAME HANGING SYSTEM RAIL 8mm

05.16300	05.16301	05.16010
BACK FRAME RAIL 8 mm 300 cm ALU BRUTE	BACK FRAME RAIL 8 mm 300 cm SILVER ANODISED	BACK FRAME POWER CORNER 8 mm (SET OF 4)

BACK FRAME HANGING SYSTEM RAIL 15mm

05.17300	05.17301	05.17010
BACK FRAME RAIL 15 mm 300 cm ALU BRUTE	BACK FRAME RAIL 15 mm 300 cm SILVER ANODISED	BACK FRAME POWER CORNER 15 mm (SET OF 4)

BACK FRAME HANGING SYSTEM ADDITIONS

05.16050	05.16055	05.16030	05.16040	05.16060
TAPE 3M 12 mm 33 M	3M VHB CLEANING TISSUES	BACK FRAME SECURITY KEY	BACK FRAME FLEX BUMPER	BACK FRAME SECURITY CLIP (4 CLIPS, 4 PLUGS, 4 SCREWS)

SET* BACK FRAME HANGING SYSTEM ON LENGTH INCLUDING 3M TAPE MOUNTED

	SET 2x BACK FRAME RAIL 8 MM 344 MM ALU BRUTE (40CM)	SET 2x BACK FRAME RAIL 8 MM 444 MM ALU BRUTE (50CM)	SET 2x BACK FRAME RAIL 8 MM 544 MM ALU BRUTE (60CM)	SET 2x BACK FRAME RAIL 8 MM 644 MM ALU BRUTE (70CM)	
	05.16725	05.16726	05.16735	05.16745	
	SET 2x BACK FRAME RAIL 8 MM 744 MM ALU BRUTE (90CM)	SET 2x BACK FRAME RAIL 8 MM 844 MM ALU BRUTE (90CM)	SET 2x BACK FRAME RAIL 8 MM 944 MM ALU BRUTE (100CM)	SET 2x BACK FRAME RAIL 8 MM 1044 MM ALU BRUTE (110CM)	
	05.16746	05.16755	05.16756	05.16765	

* SET DOES NOT INCLUDE POWER CORNERS 8MM

ARTITEQ BACK FRAME HANGING SYSTEM

A For the correct sizing and positioning of the Back Frame Hanging System, we recommend placing the profiles at 100 mm from each side of the printed panel. When glueing the profiles to the back of the printed panels, we recommend using 3M tape (article number 05.16050).

B The 8-mm and 15-mm profiles for the Back Frame Hanging System can also be mitre-cut. The profiles will fit with a wide range of accessories available on the market.

C We recommend using 3M tape (general advice 3M: 25 cm²/kg) for printed panels made of aluminium, hard-foam, forex, acryl and glass. The below table applies when Back Frame Hanging System profiles are applied at max. 100 mm from each of the sides of the printed panel (see A). The table applies for panels with a maximum total weight of 30 kg and a minimum size of 400 x 400 mm.

MATERIAL	THICKNESS	TAPE	FOR SURFACES
Dibond	3-6 mm	Single tape 12 mm	Up to 4 m ²
Forex	3-5 mm	Single tape 12 mm	Up to 4 m ²
Acryl	3-5 mm	Single tape 12 mm	Up to 4 m ²
Glass	6 mm	Double tape 24 mm	Up to 2 m ²



BEHIND WOODEN FRAMES

When hanging wooden frames or paintings, it is important to use a good frame hanger that is compatible with Artiteq's hanging systems. A frame hanger is an important component for correctly hanging a frame or painting. Artiteq has some frame hangers for a wooden frame or painting.



FRAME HANGER
1-1,5 mm STEELWIRE
(MAX. 10 kg)

ARTICLE NO. 7805.055



FRAME HANGER
1,5-2 mm STEELWIRE
(MAX. 15 kg)

ARTICLE NO. 7805.050



FRAME HANGER
FOR USE WITH WOOD

ARTICLE NO. 808.650



SET FRAME
HANGERS
L&R

ARTICLE NO. 808.600

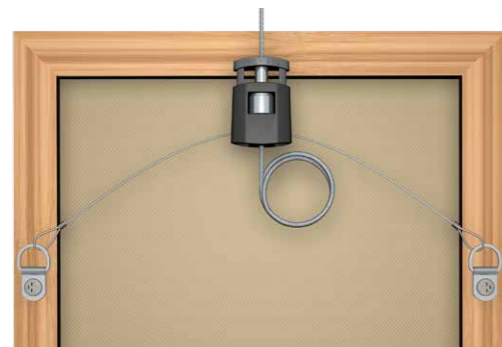

SET D-RING
(1 SET)

ARTICLE NO. 4055



D-RING HANGER

ARTICLE NO. 805.249



SCREW D-RING

ARTICLE NO. 9.4911

SPOOL



STEELWIRE
1 mm SPOOL 1x19

ARTICLE NO. 100 m

ARTICLE NO. 9.4904



STEELWIRE
1,2 mm SPOOL 1x19

ARTICLE NO. 9.4955



STEELWIRE
1,5 mm SPOOL 1x19

ARTICLE NO. 9.4990



PERLON
2 mm SPOOL

ARTICLE NO. 9.4404

ARTICLE NO. 500 m

ARTICLE NO. -

ARTICLE NO. -

ARTICLE NO. -

ARTICLE NO. 9.4421S



PRESSING NIPPLE
1-1,2 mm

ARTICLE NO. 9.4905



WIRE CLAMP
1,5 mm ALU

ARTICLE NO. 9.4430



WIRE CLAMP
2 mm ALU

ARTICLE NO. 9.4431



HANGING NIPPLE

ARTICLE NO. 9.4211

BEHIND WOODEN FRAMES



SECURITY SET

ARTICLE NO. 4054



SET FOLDING EYE
(12 PIECES)

ARTICLE NO. 4057

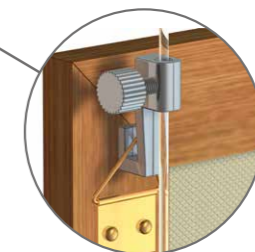

SET FRAMEHOOK +
HANGING
(12 PIECES)

ARTICLE NO. 4056

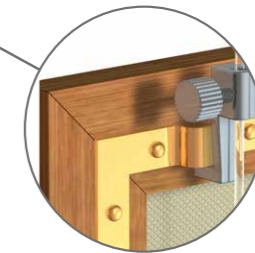

SET WALL HOOKS
(12 PIECES)

ARTICLE NO. 4059

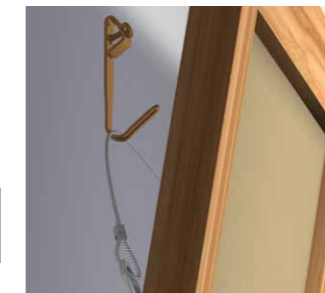

SET CONCRETE
HOOKS (4 PIECES)

ARTICLE NO. 4058



BEHIND ALUMINIUM FRAMES AND DIBOND/FOREX/PLEXIGLASS PANELS

There is also a frame hanger for aluminum frames. This hanger is attached to the back of the frame and can be used in combination with an Artiteq picture hanging system and hanging wires. For hanging a panel made of Dibond, Forex or Plexiglas, Artiteq has Dibond Hangers. These Dibond Hangers are available in 4 different sizes, each with its own maximum load-bearing capacity.

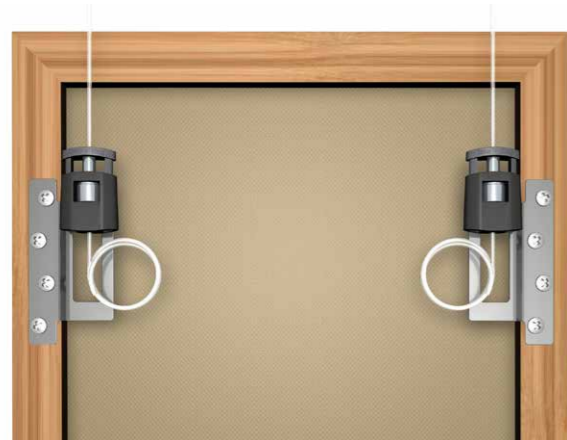

FRAME HANGER FOR USE WITH ALUMINIUM

ARTICLE NO. 808.720



DIBOND HANGER

WALL BRACKET SUPPORT DIBOND HANGER METAL

ARTICLE NO. 809.505 45 X 45 mm (MAX. 1 KG)

809.020

ARTICLE NO. 809.520 70 X 70 mm (MAX. 2 KG)

ARTICLE NO. 809.530 100 X 100 mm (MAX. 4 KG)

ARTICLE NO. 809.540 100 X 200 mm (MAX. 8 KG)



SPACERS TRANSPARENT, SELF-ADHESIVE

ARTICLE NO. 809.001 12,5 x 12,5 x 5,7 mm



SPACERS FOAM, SELF-ADHESIVE

809.002 20 x 20 x 15 mm

BEHIND ALUMINIUM FRAMES AND DIBOND/FOREX/PLEXIGLASS PANELS



SET DIBOND HANGER

SET DIBOND HANGER

ARTICLE NO. 9.6894 SET DIBOND HANGER 1ST 45 x 45mm (1KG)

ARTICLE NO. 9.6895 SET DIBOND HANGER 1ST 70 x 70mm (2KG)

ARTICLE NO. 9.6896 SET DIBOND HANGER 1ST 100 x 100mm (4KG)

ARTICLE NO. 9.6897 SET DIBOND HANGER 1ST 100 x 200mm (8KG)









* WALL BRACKET ONLY IN COMBINATION WITH DIBOND HANGERS 809.530 (100 X 100MM) AND 908.540 (100 X 200 MM).

MISCELLANEOUS ACCESSORIES

Tiles and plates can also be hung in combination with an Artiteq picture hanging system. Often a tile or a decorative plate does not have a hanging point on the back. With this Tile Hanger and Plate Hanger, however, it is possible to hang them on the wall.

Frames can tilt/hang forward when using a picture hanging system. To reduce the forward tilt this Tilt Reducer can be used. This can only be attached to a wooden frame.

MISCELLANEOUS

					
PLATE HANGER WHITE (1X) 19-28 cm (MAX. 1 kg)	TILE HANGER (1X) 32 mm (MAX. 200 GR)	SET TILE HANGER (4 PIECES)	SET ADHESIVE HANGER 30 mm	TILT REDUCER 11x5x29 mm	SET TILT REDUCER (2 STUKS)
ARTICLE NO. 807.025	808.130	4051		805.300	9.6635

